



# **CULTURAL LANDSCAPE TREATMENT PLAN**

**ROBERT ALLERTON PARK**

University of Illinois

Monticello, Illinois

**Cultural Landscape Treatment Plan**  
Robert Allerton Park  
Monticello, Illinois

*Prepared for*  
The University of Illinois

*Prepared by*  
Sasaki Associates, Inc  
*and*  
Shary Page Berg

September 2001

**TABLE OF CONTENTS**

---

**Introduction**

**1. History and Analysis**

Historical Overview

- Development of Allerton Park
- University Stewardship

Analysis of Significance and Integrity

- Historic Context
- Areas of Significance

Period of Significance

Evaluation of Integrity

Character Defining Features

**2. Treatment Overview**

Approach to Treatment

- Treatment Philosophy
- General Principles for Landscape Treatment
- Analysis/Treatment Summary Chart

General Issues and Recommendations

- Structures
- Vegetation
- Circulation
- Sculptures and Furnishings
- Programming, Interpretation and Policy

**3. *Issues and Recommendations by Garden***

Introduction and Summary Chart

Avenue of the Formal Gardens

Rose Terrace

Brick Wall Garden

Square Parterre Garden

Triangle Parterre Garden

Flower Gardens

Chinese Maze Garden

Avenue of the Chinese Musicians

Sunken Garden

Centaur

Sun Singer

Vine Walk

Fu Dog Garden

Lost Garden

**Bibliography**

**Cost Estimates**



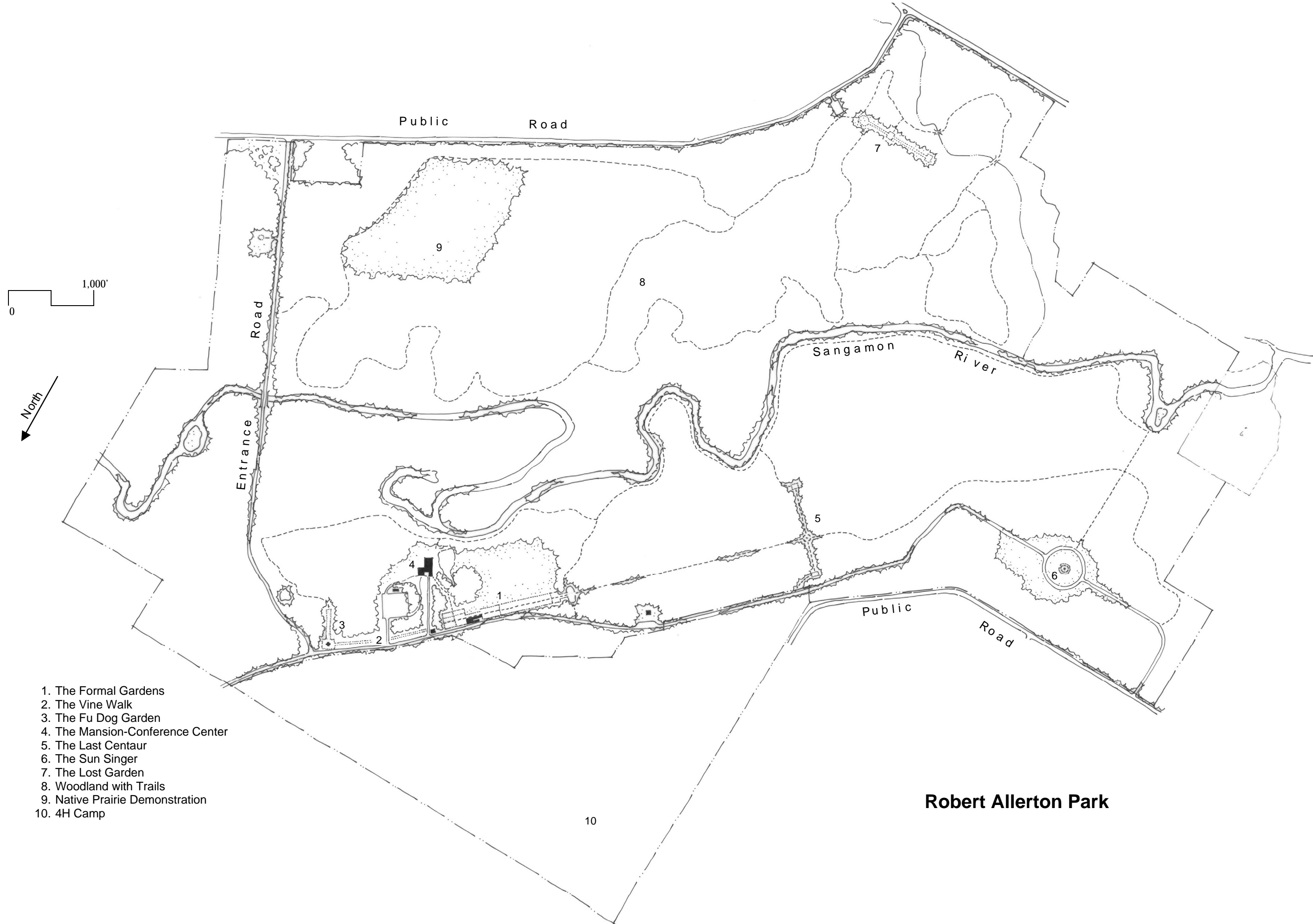

1. The Formal Gardens
2. The Vine Walk
3. The Fu Dog Garden
4. The Mansion-Conference Center
5. The Last Centaur
6. The Sun Singer
7. The Lost Garden
8. Woodland with Trails
9. Native Prairie Demonstration
10. 4H Camp

**Robert Allerton Park**

## **INTRODUCTION**

---

Between 1897 and 1946 Robert Allerton transformed his farm in Monticello, Illinois into a country estate of almost unprecedented scale. He devoted much of his life to the creation of The Farms, and to pursuing his love of landscape gardening, art and agriculture. The result was a fusion of landscape and art that is uniquely his own.

In 1946 Allerton gave the property, known today as Robert Allerton Park, to the University of Illinois, which has managed it as a conference center, 4-H club and educational resource. Over the past 50 years the university has faced many challenges in managing Allerton Park: adapting a private estate for public use; preserving fragile sculptural and landscape features; providing adequate care for large and complex resources; and dealing with conflicts between university needs and historic preservation. Various planning efforts have been undertaken over the years to address specific issues as they have arisen.

This Cultural Landscape Treatment Plan was commissioned to document the history and current conditions of the 14 formal gardens at Allerton Park and to prepare treatment recommendations, based on preservation standards established by the National Park Service. Its purpose is to provide a concise, consistent framework for evaluating the gardens, both individually and collectively, and for establishing treatment principles and identifying priority projects. Additional design work will be needed to identify plant varieties, to determine specific construction details, and to finalize cost estimates. The scope of the current project was limited to issues related to the 14 formal gardens and does not address larger cultural landscape preservation issues or the designed landscape surrounding Allerton House, which should be the subjects of a subsequent study.

This report is in three parts. Part 1 provides a brief overview of the history of Robert Allerton Park and evaluates the historical significance of the property as a whole and looks thematically at the various components of the landscape – structures, vegetation, circulation, sculptures and furnishings, as well as programmatic issues. Part 2 describes the approach to preservation treatment and provides an overview of general issues and recommendations related to the various major components of the landscape – structures, vegetation, circulation, sculptures and furnishings. Part 3 provides a more detailed look at the evolution of each of the formal gardens and summarizes issues and recommendations for each garden. For the purposes of this study, the central path is considered to be oriented east/west and other compass points are adjusted correspondingly to simplify discussion of spatial relationships.

This report was based on methodology for the preparation of cultural landscape reports developed by the National Park Service. This approach to analyzing and evaluating the significance and integrity of historic properties builds upon criteria and procedures established by the National Register of Historic Places, applying National Register methodology specifically to cultural landscapes and their associated features.

The thorough research and careful scholarship of many previous investigators into the history of Allerton Park have served as the foundation for this report. Several current staff members also assisted with this effort, notably Jerry Soesbe, David Bowman and Carol Stoddard of Allerton Park, Kevin Duff of the Office for Planning, Design and Construction, and Allen Edmondson of the University Office for Capital Planning.

## **HISTORICAL OVERVIEW**

---

*Note: The purpose of this section is to provide a brief overview of the history of Allerton Park as background for the analysis of significance and integrity that follow. Part 3 of the Cultural Landscape Treatment Plan includes more detailed information on the evolution of each of the formal gardens.*

### **DEVELOPMENT OF ALLERTON PARK**

Robert Allerton was born on March 20, 1873, the son of Samuel and Pamela Allerton. Samuel Allerton made a vast fortune buying and selling livestock during the Civil War, and amassed huge landholdings in the mid-west. He was also instrumental in the establishment of the Chicago Union Stockyards and the First National Bank of Chicago.

As a young man, Robert attended Allen Academy and Harvard School in Chicago, and was sent east to attend a prestigious college prep school, St. Paul's, in Concord, New Hampshire. He then studied painting at the Royal Academy of Bavaria in Munich, the Academy Julien in Paris, and in the teaching studios of Paris and London. In 1897 at age 23 he returned to Illinois, having decided that he lacked the talent to become a serious painter. However he remained active as a collector and patron of the arts throughout his life. He was also a successful businessman, serving as president of several banks and other businesses. By age 7 Robert had received 280 acres of farmland in Piatt County, Illinois from his father. He devoted much of his life to developing and managing his agricultural properties, called *The Farms* in Piatt County, and his homestead, known today as Robert Allerton Park. His intent was to create a country estate along the banks of the Sangamon River, and to pursue his love of landscape gardening, art and agriculture.

One of Robert Allerton's first priorities was to build a suitable house for his residence. He and architect friend John Borie traveled throughout Europe looking for country estate precedents. Ham House, a 17<sup>th</sup> century English Georgian mansion, is generally cited as the model for Borie's design for Allerton house, although many influences shaped the imposing brick mansion. Borie was also responsible for some of the early formal gardens at Allerton Park, including the Brick Wall (Vegetable) Garden, and the path connecting it with the main house, known today as the Avenue of the Formal Gardens.

In 1922 Robert Allerton met John Gregg, a young architecture student at the University of Illinois, who became his collaborator on the development of his estate and ultimately his adopted son. John Gregg Allerton, as he was later known, worked closely with Robert and was responsible for the design of many of the later gardens and the refinement of some of the earlier gardens. While the initial design precedents were primarily European, later garden influences, inspired in large measure by sculptures collected on Robert and John's travels abroad, were drawn from all over the world.

The period from 1929 to 1938 was a particularly active time for the formal gardens, when the collaboration between Robert and John resulted in many new gardens, which were increasingly fanciful in nature. While the earliest gardens at Allerton Park were largely rectilinear and enclosed, the later gardens assumed more varied form and were more closely integrated with the surrounding landscape, often featuring one or more sculptures as a focal point. In many ways the gardens reached their peak in the late 1930s. Photos from this period reveal a particularly high level of maintenance and more elaborate plantings than occurred at any other time.

In 1938 Robert, then in his mid-60s, acquired 125 acres in Hawaii and shifted his attention to the development of extensive tropical gardens at Lawai-Kai, a project to which he devoted the rest of his life. By 1941 he began to make plans to transfer his Monticello property to the University of Illinois. During World War II the gardens at Allerton Park were simplified, as Robert and John were spending less time in Illinois and increasingly focusing their attention on their new project in Hawaii. Robert Allerton died December 22, 1964, eighteen years after transferring his *Woodland Property* to the University of Illinois. John Gregg Allerton died in 1984.

#### **UNIVERSITY STEWARDSHIP**

The transfer to the University occurred on October 14, 1946. It included eight working farms containing over 3,643 acres of agricultural land (profits from which would support the park and main house), and an assemblage of 1,494 acres of natural and designed landscape, including the main house, outbuildings, network of trails, fourteen formal gardens, numerous informal garden spaces and natural areas. An additional 249 acres was set aside for a 4-H Club Camp and 4-H activities. Additional acreage has been added through gift or purchase.

The Indenture stated that the property was to be used:

*“... for education and research purposes, as a forest, wild and plant-life reserve, as an example of landscape gardening and as a public park ... “*

The Terms and Conditions of the Indenture further stated:

*“The statues, garden ornaments, ornamental garden buildings, paths and roads on the woodland property shall, so far as practicable, be kept, maintained, and preserved as they are on the date hereof....”*

Under Allerton’s stewardship the entire operation had been treated as a single unit but the University has administered it as four separate entities: farms, conference center, camp, and park, each with different interests and priorities. Public ownership has brought new challenges and there have also been impacts associated with large-scale public use of a landscape that was designed for private use. Over time the University has made changes to adapt the property to public visitation, including the addition of a new parking lot, new buildings to support conference center operations, and conversion of the greenhouse to a visitor center. Special events such as concerts and weddings have allowed people to enjoy Allerton Park in new ways but have also created additional stress on the landscape. There has also been some vandalism, which has had a particularly unfortunate effect on the sculptures at Allerton Park.

Time and environmental impacts have also taken their toll on the fragile cultural landscape. Vegetation has continued to evolve, with some formal plantings becoming over mature, other areas evolving from pastures to woodland, and loss of still other cultural plantings, particularly espaliers growing on the walls of the formal gardens. Of economic necessity many of the plantings have been simplified since 1946. Several designed landscape features, including the Lost Garden and a portion of Vine Walk, have been removed while other features, such as the *Chinese Musicians* and the *Three Graces*, have been relocated. The sculptures, many of which were not created for long-term outdoor display, have also suffered.



**CULTURAL LANDSCAPE TREATMENT PLAN**  
**ROBERT ALLERTON PARK, MONTICELLO, ILLINOIS**

---

The University has recently undertaken three major initiatives regarding the formal gardens. The first was construction of a fully accessible path system through the main gardens, which was completed in 2000. While the “crunch” of the original pea stone has been lost in some areas, the main gardens are now fully accessible to all visitors, an important commitment to public use. The second major initiative was to establish a fund raising and donor program to support preservation and restoration of the gardens. Recent projects completed through that initiative have included conservation of the *Girl with a Scarf* and rehabilitation of adjacent plantings in the Brick Wall Garden, as well as rehabilitation of the Avenue of the Chinese Musicians. These two projects led to recognition of the importance of having an overall plan to guide projects in the formal gardens, resulting in the third initiative, preparation of this Cultural Landscape Treatment Plan.

**ANALYSIS OF SIGNIFICANCE AND INTEGRITY**

---

**HISTORIC CONTEXT**

One mandate of the Cultural Landscape Treatment Plan is to evaluate the historical significance and integrity of Robert Allerton Park in relation to other properties of similar type and character. In order to evaluate the significance of a property, it must be placed within a larger intellectual framework, known as a historic context. Allerton Park fits into the context of the late 19<sup>th</sup> and early 20<sup>th</sup> century country place, a broad movement that involved the creation of many country estates during this period. Subcontexts applicable to Allerton Park are mid-western country places and gentleman's farms, as opposed to the smaller, more suburban residential estates that predominated on the outskirts of major cities such as Chicago.

The period from 1890 to 1940 has been called the golden age of American gardens. Derived from French renaissance chateaux, Italian villas, and English country homes, American country estates proliferated during this period as an expression of wealth and taste. Influenced by the architecture of the Ecole des Beaux-Arts in Paris, balance, symmetry and spatial hierarchies in architecture were transformed directly to the garden and landscape. While many of these estates were the singular creations of well-known architects, collaboration between architects and landscape architects was also widespread. Property owners, who functioned as patrons, often played a significant role as well.

Historians Mac Griswold and Eleanor Weller have compiled an overview of American estates, *The Golden Age of American Gardens, Proud Owners, Private Estates, 1890 – 1940*. This lavishly illustrated book, organized by region, provides a framework for looking at American country estates. Robert Allerton Park and Lawai-Kai are among the gardens listed.

Griswold and Weller identify basic characteristics associated with a country estate no matter where in America it might be located. These include: a long drive lined with trees, through which parkland, fields, and handsome farm buildings can be glimpsed; a formal court on the entrance front of the house; a terrace or loggia, usually on the sheltered side of the house; hedged or walled enclosures leading to a naturalistic lawn and trees that connect the house to the landscape and the view. Other features might include a lake, a wildflower garden, and usually formal gardens, sometimes organized by color or by species. There might also be a kitchen garden, a cutting garden and a greenhouse. (Griswold and Weller, 1991, page 18)

Griswold and Weller identify three major areas in the Midwest where country estates occurred during this period, Illinois, Ohio and Michigan, and divide estate gardens along formal/informal lines, although many estates combined elements of each style. While European influences remained strong, by the early 20<sup>th</sup> century there was also an emerging prairie style of landscape architecture in the mid-west, led by Jens Jensen, O.C. Simonds and others. They also categorize properties into the farm, the manor, the resort, the escape from the city, and the gardener's garden.

Allerton Park falls into the category of the farm, and indeed, at a peak of nearly 12,000 acres, is the largest of the farm properties included. Historical precedents for American gentleman's farms date to the days of George Washington and Thomas Jefferson, both of who felt that agricultural improvements were integral with pastoral pursuits. Scientific agriculture assumed new importance in the 19<sup>th</sup> century as American farming made the transition from farming for personal consumption to commercial scale operations. Griswold and Weller identify the English manor as another precedent for Allerton Park, which they found impressive in part due to the sheer size of the designed landscape. The integration of sculpture and landscape is also cited as an unusual feature, particularly on such as large scale and in such a fanciful way. Unlike those who gardened on the north shore of Chicago, where Lake Michigan served as a moderating influence for the climate,

Allerton was forced to rely heavily on hardy plant materials, bringing native vegetation into the formal gardens because it was all that could survive. Griswold and Weller characterize Allerton Park as “. . . a Shangri-la, a passionately eclectic, Art Deco-flavored, American estate garden.” (Griswold and Weller, 1991, page 271).

#### **AREAS OF SIGNIFICANCE**

Assessment of historical significance in the context of this project is difficult for several reasons. First of all this Cultural Landscape Treatment Plan focuses only on the 14 formal gardens, which are only a small part of Robert Allerton Park. Their significance cannot be evaluated in a meaningful way independently of the larger property. Secondly the property reflects a personal rather than a universal sense of taste, is eclectic in style, and does not fit neatly into the established design precedents of the day. This preliminary evaluation of the historical significance of Allerton Park and the role of the formal gardens in contributing to significance is based on the four criteria established by the National Register of Historic Places. In order to be eligible for listing on the National Register a property must only meet one of the criteria. Historic resources may be determined eligible at the local, state or national level.

##### ***Criterion A: Association with Events, Activities or Trends***

In order to be determined eligible under Criterion A, a property must be associated with events that have made a significant contribution to the broad patterns of our history as defined in the relevant historic context. Although no formal evaluation of the property as a whole has occurred, Allerton Park is generally considered to be significant at the state level as a late 19<sup>th</sup> and early 20<sup>th</sup> century country place and as an expression of the personal vision of Robert Allerton. This informal evaluation is based on the scale and complexity of the property, the integration of diverse landscape and architectural components, and the integrity of the property as a whole.

##### ***Criterion B: Association with a Person***

In order to be determined eligible under Criterion B a property must be associated with the lives of persons significant in our past as identified in the relevant historic context. Robert Allerton, active in business and the arts, as well as in developing Allerton Park, was a relatively private individual whose contributions are not widely recognized. Additional research would be needed to establish significance beyond the local level for Criterion B.

##### ***Criterion C: Design: Landscape Architecture***

In order to be determined eligible under Criterion C a property must embody the distinctive characteristics of a type, period or method of construction; represent the work of a master; possess high artistic values; or represent a significant and distinguishable entity whose components may lack individual distinction. The fourteen formal gardens are individually and collectively an important aspect of Allerton Park and contribute to its overall significance. They are similar in scale to other midwestern estate gardens of the period but lack the design sophistication of some of the better-known gardens along the north shore of Chicago.

Allerton Park was largely the creation of Robert Allerton, working initially with architect John Borie and James Gamble Rogers, then with Joseph C. Llewellyn and Associates, and later with John Gregg Allerton. John Borie and John Gregg Allerton, who were primarily responsible for the design of the gardens, are not widely recognized as designers. Thus the formal gardens cannot be considered significant as an example of their work as there is insufficient information to establish them as eligible for Criterion C. However, the gardens do meet Criterion C as an example of large-scale formal gardens associated with a major country place.

***Criterion D: Likely to yield information in history or prehistory (archeology)***

In order to be determined eligible under Criterion D, a property must have yielded, or be likely to yield information important in history or prehistory. There is currently insufficient information to make a determination of eligibility under Criterion D.

In summary, Allerton Park appears to meet National Register Criteria A and C at the state level as an example of a large-scale country estate that integrates the natural landscape, agriculture, the designed landscape, architecture, and sculpture into a unified vision that is a personal expression of the property's original owner, Robert Allerton. The formal gardens contribute substantially to the overall significance of the property.

**PERIOD OF SIGNIFICANCE**

The period of significance for the formal gardens as a designed landscape extends from circa 1900 when the first garden spaces were laid out to 1946 when Robert Allerton gave the property to the University of Illinois. During the nearly 50 years of Allerton's stewardship, the gardens achieved their fullest expression as a designed landscape. The chart at the beginning of Part 2 summarizes the evolution of each garden. The period of University stewardship (1946 – 2001) is not historically significant. Changes since 1946 have been primarily pragmatic in nature rather than design innovations and most are categorically excluded from National Register eligibility because they have occurred within the past 50 years.

**EVALUATION OF INTEGRITY**

Integrity is the authenticity of a property's historic identity or the extent to which a property evokes its appearance during a particular historic period. While evaluation of integrity is often a subjective judgment, particularly for a landscape, it must be grounded in an understanding of a property's physical features and how they relate to its significance. The National Register identifies seven aspects of integrity: location, design, setting, materials, workmanship, feeling and association. Retention of these qualities is essential for a property to convey its significance. In the following analysis, the integrity of the formal gardens is evaluated for the period of significance, which extends from 1900 to 1946.

***Location***, the place where the historic property was constructed or the historic event occurred, remains constant for the property and is present for each of the gardens.

***Design*** is the combination of elements that create the form, plan, space, structure and style of a property. The overall landscape character and spatial organization for the formal gardens remains high except for the Lost Garden and to a lesser extent the Vine Walk. Design details, particularly vegetation and sculptures, have changed over time and have less integrity.

***Setting*** is the physical environment of a historic property, which has changed relatively little for the formal gardens, although there have been some changes to accommodate modern uses.

***Materials*** are the physical elements of a particular period, which include walls, paths, plant materials, sculptures and other landscape features. Structural features at Allerton Park tend to have a high degree of integrity while plant materials and sculptures have changed more over time. In particular, plant materials have been simplified and no longer fully reflect the diversity of the original plant palette.



**Workmanship**, which includes the physical evidence of the crafts of a particular period, is largely intact in the overall aspects of the design but has been lost somewhat in the details, which tend to be more ephemeral. Landscape workmanship reached its peak during the late 1930s and has declined since that time.

**Feeling**, a property's expression of the aesthetic or historic sense of a particular period, remains a strong contributing aspect of the property, although the landscape has grown up over time and some changes have made it slightly more institutional in character.

**Association**, the direct link between an important historic event or person and a historic property, remains strong for this property, as it remained in Robert Allerton's ownership for over 50 years and has had only one owner since then.

In summary, the formal gardens as a whole, with the exception of the Lost Garden, and to a lesser extent the Vine Walk, have a high level of integrity, even though individual features have diminished integrity.

#### **CHARACTER DEFINING FEATURES**

A character-defining feature is a prominent or distinctive aspect, quality or characteristic of a historic property that contributes significantly to its historic character. Understanding character defining features is critical in planning for preservation and use of a historic property, and for determining treatment priorities. The list below is an overview of character defining features for the formal gardens as a whole. Character defining features for each garden are listed in Part 3.

##### ***Spatial Organization/Landscape Character***

- Unified assemblage of 14 formal gardens of significant scale, integrated within a larger designed landscape setting. Gardens created as the singular vision of Robert Allerton, with involvement of Borie, Rogers, Llewellyn, and John Gregg Allerton.
- Central gardens organized as garden rooms along connected spine, most are rectangular with enclosing walls and are more or less symmetrical. Gardens in outlying areas are less formally structured, with softer edges, and are more integrated with surrounding landscape.
- The primary organizing idea of the gardens is the central axial pathway. Compartmentalization of the gardens into separate rooms means that they must be viewed sequentially to be comprehended. The combination of static symmetrical axial order with the dynamic element of time and anticipation results in a landscape that is both powerfully unified and spatially engaging.
- Repetition of single design elements over large areas. Examples include 930 feet of Wisteria at the Vine Walk, and 385-foot by 35-foot peony bed bounded by an eight-foot wide band of blue iris.
- Views along paths, within garden spaces, and periodically out to surrounding area.
- Topography generally level, subtle changes treated with steps. Sunken Garden, Centaur setting and Lost Garden are exceptions.

**Structures**

- Garden spaces typically enclosed by brick or concrete walls or vine trellises, which define spaces and form visual corridors. Some of the walls are an unusually early example of hand formed concrete work.
- Structures used as accents in the landscape (House of Golden Buddhas, stair tower in Triangle Parterre Garden, pylons in Centaur area). Many of these designed by John Gregg Allerton.
- Stairs and gateways serve as transitional elements between gardens.

**Vegetation**

- Plantings generally formal and highly structured, and often used in pairs or as symmetrical plantings along a walkway to define spaces.
- Evergreens used as hedging to line main path and create visual corridor. Amur privet hedging used to create maze patterns (Square Parterre Garden, Triangle Parterre Garden, Chinese Maze Garden). Fastigate evergreens used as visual accents in the landscape.
- Vine trellises, usually covered with wisteria, serve dual purpose of defining spaces and forming deer resistant edges to gardens.
- Major floral displays mostly limited to Flower Gardens.

**Circulation**

- Central path is primary organizing feature of main gardens. Path was previously pea stone, now most sections are exposed aggregate concrete for ADA access. Gardens generally designed to be viewed from this path.
- Most paths in formal gardens straight rather than curved (except southern end of Avenue of Formal Gardens) and enclosed by vegetation or sculptures.
- Path becomes more informal as it moves beyond Sunken Garden into woodland areas, linking with woodland trails.
- Sun Singer is the only major garden space directly accessible by automobile.

**Sculptures/Furnishings**

- Early sculptures classical in character generally used as landscape features rather than work of art (Assyrian lions, urns, etc.).
- Later sculptures Art Deco (Sea Maidens) or Oriental influence (Fu Dogs, Japanese Guardian Fish, Hari Hara, etc.).
- Centaur and Sun Singer are unique in being monumental sculptures for which a setting was designed.
- Many of the sculptures were moved several times as Allerton developed new gardens.

- Furnishings consist primarily of benches, mostly of marble or limestone.

## **PART 2 – TREATMENT OVERVIEW**

---



## APPROACH TO TREATMENT

---

### TREATMENT PHILOSOPHY

This section provides an overview of recommendations for landscape preservation treatment for the formal gardens at Robert Allerton Park. It includes general principles and approaches to landscape treatment, a chart summarizing treatment recommendations for each garden, and a summary of issues associated with major features in the landscape.

The Secretary of the Interior's *Standards for Historic Preservation Projects and Guidelines for Cultural Landscapes* provide a framework for analysis and treatment, which is based on the recognition of certain aspects of the property as character defining. While Allerton Park has changed over time, character defining features are central to the identity of the property and should be preserved. A list of character defining features for the formal gardens as a whole is included in Part 1. Character defining features for individual gardens are described in Part 3.

The *Standards for Treatment of Historic Properties* identify four possible treatments for historic resources. The implications of each treatment for the formal gardens at Allerton Park are summarized below.

- **Preservation** – Preservation recognizes the value of a property as it has evolved over time and is often used where a property retains a high level of integrity. This treatment allows replacement of existing features in kind, but does not permit major modifications or the addition of new features. For most of the formal gardens at Allerton Park, preservation is the primary treatment recommended, although exceptions are made in many cases for vegetation, which generally has less integrity than other aspects of the gardens. At the Lost Garden, where only remnants of the designed landscape remain, preservation is also the recommended treatment.
- **Restoration** – Restoration involves recreating the appearance of a property or feature as it existed at some point in the past. Restoration to an earlier period can present difficult technical and philosophical questions, so the implications of this approach must be carefully evaluated before work is undertaken. Restoration of plantings to their circa 1946 appearance is recommended for gardens where there is clear documentation and the current appearance of the garden does not fully convey the intended visual effect. This includes the Rose Terrace, the Chinese Maze Garden, the Fu Dog Garden and the larger landscape setting of the Centaur and the Sun Singer.
- **Reconstruction** – Reconstruction involves complete rebuilding of a feature or landscape that no longer exists. This approach is appropriate only if the feature or landscape has been destroyed, is determined to be so significant that its re-creation is critical to the interpretive mission of the park, and if there is adequate historical documentation and management support to ensure long-term care for the reconstruction. Major missing features associated with the formal gardens include the Lost Garden and the west end of the Vine Walk. Reconstruction of the Lost Garden is not recommended. Reconstruction of the west end of the Vine Walk is recommended because it would restore unity to the remaining portion of the Vine Walk.
- **Rehabilitation** – Rehabilitation preserves character-defining features but allows changes that would improve the utility or function of a property. This is the most flexible preservation treatment, as it permits modifications for contemporary use and allows the restoration of important features where doing so is critical to the character of the property. In cases where vegetation has evolved over time and restoration is not feasible due to physical conditions,

management considerations, or plant availability, rehabilitation of plantings is recommended. For example rehabilitation is recommended for the Avenue of the Formal Gardens, where the original plantings did not do well and where the surrounding forest has grown up to create a much shadier environment. The recent work at the Avenue of the Chinese Musicians is a rehabilitation of the post-1977 garden.

#### **GENERAL PRINCIPLES FOR LANDSCAPE TREATMENT**

Allerton Park has seen many changes over time, but for nearly 50 years there was a singular vision for the cultural landscape and its central formal gardens. This was begun by Robert Allerton around 1897 and continued through 1946. From 1900 to 1938, Allerton Park was the primary focus of Robert Allerton's interest and many of the gardens reached their fullest expression in the late 1930s. After 1938, Allerton turned his attention to Lawai-Kai, his newly acquired property in Hawaii, and by 1941 he began to make plans to transfer Allerton Park to the University of Illinois. Changes made in the early 1940s were part of Allerton's vision for the future of the property as a public institution and should be recognized as part of the overall evolution of the gardens. The gardens are also particularly well documented at this transition point, in plans, photographs and a written list of plant materials. The terms and conditions of the 1946 indenture between Allerton and the University recognize the need for some change but also express Allerton's wish that, as much as feasible, garden features remain as they were at the time of the transfer.

Over the past half century of University stewardship, there have been many changes, some necessitated by the transition to public use; others by the evolution of plant material or other environmental forces; and still others of a more arbitrary nature. This Cultural Landscape Treatment Plan presents an opportunity to review how the gardens developed initially, how they have evolved over time, and to develop a comprehensive vision for their future. That vision is based on their historical significance, the intent of Robert Allerton's gift, current site conditions, and management considerations.

The recommended treatment approach is to preserve character defining features: the spatial organization, structural features, circulation system, arrangement of plant materials, and placement of sculptures, most of which retain a high level of integrity to the 1946 period. Limited restoration to the 1938 - 1946 period is recommended for plantings and other small-scale features that have been altered since that time and no longer reflect their design intent. In cases where missing or damaged features cannot be restored because historical documentation is lacking, environmental conditions have changed, or there are overriding management considerations, rehabilitation is recommended.

The chart on the next page provides a brief summary of analysis and treatment recommendations for the fourteen formal gardens commissioned as part of this treatment plan. Other cultural landscape elements (i.e. informal gardens, shelterbelts and windbreaks, managed forests, savanna, etc), expressly outside the commission of this plan, should be reviewed at a future date. More detailed recommendations for each formal garden are provided in Part 3.

Before further modifications are made to the landscape, changes should be carefully evaluated for their impact on the character-defining features, as described in the preceding section, and for their adherence to the following principles.

- Preserve extant spatial organization and historic fabric of gardens established by walls, paths and planting beds.

**CULTURAL LANDSCAPE TREATMENT PLAN  
ROBERT ALLERTON PARK, MONTICELLO, ILLINOIS**

---

- Preserve axial circulation system as the central organizing feature of the landscape.
- Restore or rehabilitate plantings to re-establish design intent where vegetation has become overgrown or no longer functions as intended.
- Preserve sculptural elements within the landscape, with highest priority given to artistically significant pieces.
- Preserve unity of design and materials. Keep new features within the landscape to a minimum. Necessary additions (interpretive signs, donor plaques) should be simple, unobtrusive in design and dark or neutral colored using a consistent palette of simple, unobtrusive materials.

**ANALYSIS/TREATMENT SUMMARY CHART**

<b><i>Garden</i></b>	<b><i>Analysis</i></b>	<b><i>Treatment</i></b>
Avenue of Formal Gardens	Path established circa 1902. Primitive Men in place since 1922. Vegetation and path width modified over time.	Preserve extant features, rehab vegetation.
Rose Terrace	Terrace established circa 1905. Sea Maidens in place since 1935. Vegetation modified over time.	Preserve extant features, restore John Allerton's intended plantings (elms).
Brick Wall Garden	Spatial organization and circulation established in 1902. Vegetable garden until 1940s. Current plantings evolved from 1940s treatment. Girl with Scarf in place since 1942.	Preserve extant features, rehab plantings to create more visual interest, based on historic precedent.
Square Parterre Garden	Garden assumed current form by 1918. Urns added by 1930.	Preserve extant features, minor restoration of plantings to re-establish design intent.
Triangle Parterre Garden	Spatial organization and plantings in place since 1930. No major changes since then.	Preserve extant features, rehab/restore plantings to re-establish design intent.
Flower Gardens	Gardens established current form by 1920s. Vegetation simplified over time.	Preserve extant features, rehab/restore plantings to re-establish design intent.
Chinese Maze Garden	Garden established in 1912. Chinese goldfish added 1925. Borie gates added 1930.	Preserve extant features, restore plantings to reestablish design intent, including espaliers.
Avenue of Chinese Musicians	Space established by 1912. Chinese Musicians moved here in 1977.	No changes recommended. Rehab work recently completed in central section.
Sunken Garden	Upper walls built by 1925, lattice in place by 1938. Minor changes in plantings and surface materials since then.	Preserve/restore extant features, rehab turf to accommodate use.
Centaur	Centaur in place by 1929. Major change is	Preserve area around Centaur.

**CULTURAL LANDSCAPE TREATMENT PLAN  
ROBERT ALLERTON PARK, MONTICELLO, ILLINOIS**

---

	loss of detail in outlying areas of setting (corridor, pylons, cauldrons).	Restore larger designed landscape setting.
Sun Singer	Sun Singer in place by 1932. Few changes except growth of forest.	Preserve Sun Singer, restore open prairie behind sculpture.
<b><i>Garden</i></b>	<b><i>Analysis</i></b>	<b><i>Treatment</i></b>
Vine Walk	Vine walk laid out 1915. House of Golden Buddhas completed 1924. West end of vine walk removed 1950s.	Preserve extant section, restore structure and vegetation as needed.
Fu Dog Garden	Garden established in 1932, minor changes in 1930s. Fir trees have grown out of scale.	Preserve extant features, restore vegetation to re-establish design intent.
Lost Garden	Tea house burned in 1972, garden now overgrown, sculptures removed.	Preserve garden as it presently exists.



**GENERAL ISSUES AND RECOMMENDATIONS**

---

*The preceding section established an overall framework for treatment of the formal gardens at Allerton Park. This section addresses various categories of resources within the gardens by grouping similar projects, identifying common themes; and establishing relative priorities. Resources are divided into four categories: structures, vegetation, circulation, and sculptures/furnishings, followed by a brief discussion of programming and interpretation.*

**STRUCTURES**

***Walls and Vine Trellises***

High walls that enclose garden spaces are character defining features of the formal gardens, particularly the older gardens. These include the brick walls of the Brick Wall (Vegetable) Garden; the concrete walls of the Flower Gardens, Chinese Maze Garden and the Sunken Garden; and the wooden walls between the Chinese Maze Garden and the Avenue of the Chinese Musicians. Some of these walls are an early example of hand formed concrete. Vine trellises, which can be found in conjunction with a number of the gardens, are a unique type of fencing associated with Allerton Park. The vine trellises consist of tall wire fences planted with ornamental vines, which serve a triple function as space definers, as barriers (especially for deer) and as decorative elements. Many of these features are nearly a century old and are showing signs of settling, structural deterioration and surface degradation.



**2001** – Some sections of the Sunken Garden wall, such as this area where two sections have separated, require structural stabilization. There are also issues associated with surface treatment and minor losses.



**2001** – The brick walls surrounding the Brick Wall Garden (seen here from the Square Parterre Garden) must be repaired prior to any rehabilitation of plantings. The spalling evident in this photo may be due to problems with an improper capstone.



**2001** – The rough texture of the concrete walls is an inherent characteristic of their construction, but when losses have increased to a point where they threaten the structural stability of the wall, they must be repaired.



1918 (HGFD-1) – This early view shows the structure of the Vine Walk trellis before planting.

### ***Freestanding Structures***

Freestanding structures at Allerton Park typically serve as focal points or destinations in the landscape. These include the House of the Golden Buddhas; the pylons associated with the *Centaur*; and several stair towers. Sculpture bases are discussed in a subsequent section.



2001 – The House of the Golden Buddhas is a focal feature that is in need of careful rehabilitation. This is a discreet project that could be undertaken independently of other work. The first step should be preparation of a Historic Structures Report.



**2001** – Pylons associated with the outlying spaces of the Centaur indicate serious deterioration, including evidence of recent losses. This hazardous condition should be rectified as soon as possible

***Summary of Structural Recommendations***

Major structural projects are listed below. Many of these are substantial projects that must be undertaken before other work can begin. Several student projects have documented problems associated with the walls and have developed options for their repair. The University has also obtained cost estimates for some repairs. In most cases a more thorough analysis is needed before detailed recommendations and budgets can be prepared. All treatments should be made in accordance with the Secretary of the Interior's Standards under the supervision of someone experienced in dealing with historic resources.

***Priority 1 – Urgent Need***

- Repair/Replace Pylons (Centaur, 10A) - High priority, potential safety hazard.

***Priority 2 – Moderate Need***

- Repair Brick Perimeter Walls (Brick Wall Garden, 3A)
- Restore arch in Stair Tower and Remove Foundation (5E &G)
- Repair Concrete Walls (Flower Gardens, 6A and Chinese Maze Garden, 7B)
- Repair Concrete Walls, Pylons and Lattice (Sunken Garden, 9A, 9B)
- Repair Brick Columns, Repair/Reconstruct Trellising (Vine Walk, 12E, and elsewhere)
- Rehab House of Golden Buddhas (Vine Walk, 12A)
- Reconstruct Stair Towers (Chinese Maze Garden, 7E)
- Remove post 1946 foundation (Triangle Parterre, 5K)

**VEGETATION**

Vegetation is the aspect of Allerton Park that has changed the most over time. It is also the resource with by far the largest number of recommendations. Issues fall into three major categories, which are highlighted below.

***Overgrown Plant Material***

The very nature of formal plantings is that they become overgrown in time, destroying the intended design effect. The need to replace overgrown plants, particularly in the more formal spaces, is one of the primary vegetation issues facing Allerton Park. This includes the many hedges that have grown out of scale, as well as larger plantings that have lost their intended scale and shape.



**1930 (HGTO-6)** This view of the Triangle Parterre Garden shows plantings in scale with the space.



**2001** – This current view shows arborvitae that have grown out of scale.

***Transformation From Open Field to Forested Landscape***

When Robert Allerton began making improvements, he created a designed landscape in open fields. Today the surrounding forest has grown up, presenting new challenges for understanding design intent and making treatment recommendations. The photographs below, all taken from the upper level of the House of the Golden Buddhas, illustrate changes in the Fu Dog Garden.



**1932 (HGFC – 1)** Firs were initially planted to define the space.



**1944 (HGFC-8)** Firs have reached intended size and shape.

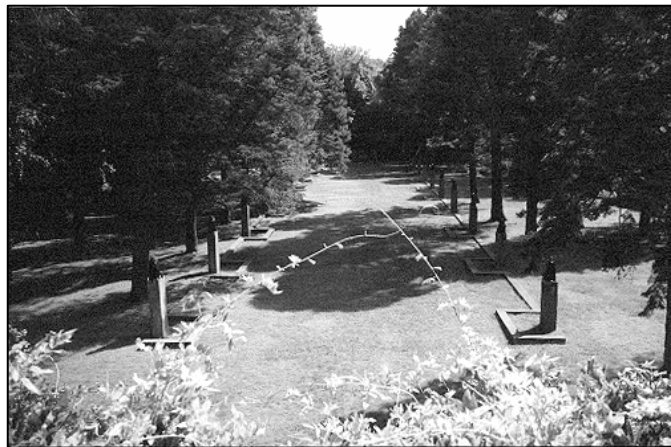

**2001** Firs have become over mature, dominating the space and overshadowing the Fu Dogs.

### **SIMPLIFICATION OF PLANTINGS**

Another significant change within the formal gardens has been the simplification of plant material. This is particularly evident in the flower gardens, which were high maintenance spaces that have lost much of their horticultural complexity and visual interest. The peony garden, initially a regionally significant collection containing 135 varieties, now consists of only 35 varieties. The bulb garden, formerly a showcase of bulbs supplemented by annual plantings, is now weedy with a limited palette. In the Brick Wall Garden plantings were deliberately simplified prior to transfer to the University. The current plantings do not reflect former use of this area as a vegetable garden and do not work well as a display garden.

Over time the number of species has been reduced to those that are reliably hardy in central Illinois, but these do not always provide the intended effect. For example, Allerton initially used many different types of upright evergreens but many of these species (such as Irish juniper) have been replaced with hardier species that often have a different appearance. New varieties developed over the past 50 years may present an opportunity to restore some of the intended design effect. In other cases, particularly in the use of evergreens, more compact varieties can retain the intended scale of plantings and reduce the need for frequent replacement. The recommendation to plant disease-resistant elms on the Rose Terrace is another case where new plantings can be used to restore the intended design.

### ***Summary of Recommendations for Vegetation***

Unlike structures, which are organized solely by priority, vegetation projects are divided into two groups. The first group, characterized as maintenance projects and designated by the letter M, includes pruning and removal of dead or overhanging trees. The second group involves larger initiatives that require more extensive design and would need to be budgeted as capital projects.

#### ***Priority 1 – Pruning/Maintenance Projects***

- Brick Wall Garden (3M1)
- Flower Gardens (6M1)
- Chinese Maze (7M1)
- Chinese Musicians (8M2)
- Sunken Garden (9M1)
- Lost Garden (14M1)

#### ***Priority 2 – Restoration/Rehabilitation Projects***

- Ave. Formal Gardens (1A,B)
- Rose Terrace (2A)
- Brick Wall (3B)
- Triangle Parterre (4A, B, C)
- Square Parterre (5A, B, C, D)
- Flower Gardens (6C, D, E, G, H)
- Chinese Maze (7A, C, E)
- Sunken Garden (9E, F, G)
- Centaur (10D, E, F, G)
- Sun Singer (11B, C)
- Vine Walk (12C, D, E)

- Fu Dog Garden (13B, C, D)

**SCULPTURES AND FURNISHINGS**

Sculpture was an integral feature of Robert Allerton's gardens from the beginning. However, for the most part, the sculptures were intended as landscape features, rather than as works of art. The two major exceptions are the *Centaur* and the *Sun Singer*, both monumental sculptures that Allerton acquired relatively late in the development of the park, that are the focus of major spaces within the formal garden complex. In both cases, the sculptural setting is an integral component with the work of art. These landscape settings have both evolved over time, reducing their intended impact.



**1935-40 (HGCN-17)** – In this early view from the *Centaur*, the pylons are a visible and integral component of the landscape setting.



**2001** – Today the pylons are all but lost from view.



Today Allerton Park contains a range of sculptures, ranging from nationally renowned works of art to reproductions of dubious quality. Many of these pieces are fragile and are suffering from environmental issues (pollution, insects, plant droppings) as well as visitor impacts. Preserving the often-fragile sculpture collection has been an ongoing challenge for the University.



**2001** – The Japanese Guardian Fish at the Sunken Garden illustrate the difficulty of preserving fragile works of art in a wooded setting. They have lost their gilding and are threatened by overhanging trees.

The most comprehensive inventory of artwork at Allerton Park was undertaken by Muriel Scheinman in 1981 as part of a doctoral thesis on art collecting at the University of Illinois. Scheinman provides a brief description of each of the pieces and an overview of the collection as a whole. More recently, evaluations and treatment reports have been sought for individual pieces or small groups of sculptures. These documents contain specific treatment recommendations that should guide the preservation and ongoing care of specific pieces.

***Summary of Recommendations for Sculpture***

The chart below summarizes projects related to sculpture and furnishings. The first group of projects are those that involve minor conservation or ongoing maintenance. The second group are those that require more extensive care or conservation. Within this group, highest priority should be given to conservation of sculptures that are artistically significant, are in very visible locations, or are threatened. The last group of projects include sculptures that should be recarved or relocated. Several sculptures, notably the *Centaur* and the *Sun Singer*, have issues related to their bases or pedestals.

***Minor Conservation/Maintenance Projects***

- Primitive Men (1C)
- Benches (1D)
- Girl with Scarf (3C)
- Fruit Baskets (3C)
- Benches (3D)
- Lions and Basalt Sculpture (5E)
- Chinese Musicians (9D)
- Goldfish and Benches (10A)
- Centaur (10C)

***Major Conservation Projects***

- Sea Maidens/Columns (2D)
- Replace/Conserve Chinese Goldfish (7D)
- Japanese Guardian Fish (9C)
- Chinese Goldfish and Benches (9D)
- Swedish Cauldrons (10B)
- Sun Singer, including pedestal and base (11A)
- Siamese Buddhas and Hari-Hara (12B)
- Fu Dogs (13A)

***Other Projects***

- Replace/recarve Urns and Bases (4C)
- Recarve Adam (6B)
- Relocate Three Graces (6G)
- Eliminate Extra Layer of Sculpture Base at Centaur (10I)

**CIRCULATION**

Many circulation issues have been addressed with the construction of the ADA path in 2000. Most of the remaining issues are relatively minor and can be undertaken in conjunction with work on individual gardens. The exception is the need to repair and resurface the road leading to and around the *Sun Singer*, which is considered a part of the overall road rehabilitation program rather than specific to this particular garden and thus is not addressed in detail.

***Summary of Recommendations for Circulation***

- Rose Terrace (2C)

- Bulb Garden (6J)
- Sunken Garden (9H)

**PROGRAMMING, INTERPRETATION, POLICY**

The primary focus of this treatment plan is on preservation recommendations for physical features within the formal gardens. However, several issues regarding programming and interpretation have also been identified in the course of this project and are noted below.

***Brochures and Interpretive Signage***

The visitor center is an excellent resource for people who arrive in the central portion of the gardens. An expanded map and guide should be provided for visitors to carry away with them. Interpretive signs are recommended for outlying gardens at which visitors might arrive without stopping at the visitor center (Centaur, Sun Singer, Vine Walk, Fu Dog Garden, Lost Garden). To assure a consistent and high quality effect, this project should be undertaken as part of an overall interpretive media plan rather than on an ad hoc basis.

***Donor Signage***

Donor signs should be limited to major donations and should be as unobtrusive as possible.

***Programming***

Some spaces lend themselves to programmed events and should be adapted to handle such use. For example if use of the Sunken Garden is to be expanded, it will need to have heavy duty turf with new drainage and irrigation systems to accommodate the impacts of increased visitation. An electrical feed could also be installed to provide for sound systems and lighting.

***Irrigation***

Lack of irrigation makes care of plant materials difficult. A complete irrigation system for the formal gardens would facilitate their care and maintenance. An alternative would be to consider permanent irrigation for heavily used or difficult to maintain spaces and temporary irrigation for newly established plantings.

***Inspections***

Conduct annual inspections of all structures, particularly those in remote areas like the Lost Garden.

**PART 3 – RECOMMENDATIONS BY GARDEN**

---

**CULTURAL LANDSCAPE TREATMENT PLAN  
ROBERT ALLERTON PARK, MONTICELLO, ILLINOIS**

---

**INTRODUCTION AND SUMMARY CHART**

---

Part 2 of the Treatment Plan addressed general issues of treatment philosophy and looked at recommendations associated with major features such as structures, vegetation, circulation and sculptures. This section (Part 3) is organized by individual garden. The following information is provided for each garden:

- **Garden Evolution** – a visual overview of the evolution of each garden using historic photographs from the Allerton collection (*Note: existing conditions photos still to be added*)
- **Description** – a brief narrative describing the history and appearance of each garden
- **Character Defining Features** – a list of features that contribute to the history and significance of each garden
- **Issues and Recommendations** – an overview of treatment issues and a list of recommended projects, accompanied by a map

The chart below provides a concise summary of all capital recommendations by garden. Maintenance recommendations for some of the gardens are included in the discussion regarding the individual gardens but are not included here. See reports on individual gardens for additional detail on each recommendation.

**RECOMMENDATIONS SUMMARY CHART**

	<b>Structures</b>	<b>Vegetation</b>	<b>Sculpture</b>	<b>Circulation</b>
<b>Avenue of Formal Gardens</b>				
1A Rehab vegetation – southern end		●		
1B Rehab vegetation – northern end		●		
1C Clean/conservate primitive men			●	
1D Clean/reset benches			●	
<b>Rose Terrace</b>				
2A Restore terrace plantings – elms, etc.		●		
2B Rebuild concrete steps				●
2C Clean/conservate sea maidens and columns			●	
<b>Brick Wall Garden</b>				
3A Repair brick perimeter walls	●			
3B Restore/rehab plantings		●		
3C Preserve sculptures			●	
3D Clean/reset benches			●	

**CULTURAL LANDSCAPE TREATMENT PLAN  
ROBERT ALLERTON PARK, MONTICELLO, ILLINOIS**

	<i>Structures</i>	<i>Vegetation</i>	<i>Sculpture</i>	<i>Circulation</i>
<b><i>Square Parterre Garden</i></b>				
4A	Reduce height/width of parterres	●		
4B	Restore east wall plantings	●		
4C	Restore west wall plantings	●		
4D	Provide replacement urns		●	
<b><i>Triangle Parterre Garden</i></b>				
5A	Reduce height/width of parterres	●		
5B	Replace arborvitae in triangles	●		
5C	Replace arborvitae, north/south edges	●		
5D	Restore/rehab west wall plantings	●		
5E	Restore historic arch in stair tower	●		
5F	Clean/conservate lions and sculpture		●	
5G	Remove foundation at north side	●		
<b><i>Flower Gardens</i></b>				
<i>General</i>				
6A	Repair concrete walls			●
6B	Recarve Adam		●	
6C	Arborvitae at main path	●		
6D	Replace cedars along southern edge	●		
<b><i>Peony Garden</i></b>				
6E	Restore vines on walls	●		
6F	Restore peony/iris plantings	●		
6G	Relocate Three Graces		●	
<b><i>Bulb Garden</i></b>				
6H	Restore bulb display	●		
6I	Replace missing north/south walkways			●
<b><i>Annual Garden</i></b>				
6J	Restore espalier plantings on east wall.	●		
<b><i>Chinese Maze Garden</i></b>				
7A	Reduce height/width of hedges	●		
7B	Repair concrete walls	●		
7C	Strengthen espalier wall plantings	●		
7D	Replace/conservate Chinese Goldfish		●	
7E	Reconstruct stair towers	●		
7F	Replace arborvitae in corridor	●		

**CULTURAL LANDSCAPE TREATMENT PLAN  
ROBERT ALLERTON PARK, MONTICELLO, ILLINOIS**

	<i>Structures</i>	<i>Vegetation</i>	<i>Sculpture</i>	<i>Circulation</i>
<b><i>Avenue of Chinese Musicians</i></b> No capital projects are recommended for this garden				
<b><i>Sunken Garden</i></b> 9A Repair concrete walls and pylons 9B Repair/replace lattice on upper wall 9C Clean/conservé Guardian Fish 9D Clean/conservé Goldfish and benches 9E Replace hemlocks 9F Replace turf, irrigation, drainage 9G Clear vista towards Centaur 9H Add concrete pad and rail at south end 9I Provide electric feed for special events	● ●	● ● ●	● ●	●
<b><i>Centaur</i></b> 10A Repair/replace pylons 10B Conservé Swedish cauldrons 10C Preserve Centaur 10D Regrade/replant at sculpture base 10E Prune forest corridor and around Centaur 10F Restore ornamental plantings 10G Phase out hemlocks 10H Redesign path at north space 10I Eliminate extra layer of sculpture base	●	● ● ● ●	● ● ●	●
<b><i>Sun Singer</i></b> 11A Conservé Sun Singer, replace pedestal 11B Replant around sculpture base 11C Prune back woodland behind statue		● ●	●	
<b><i>Vine Walk</i></b> 12A Rehabilitate House of Golden Buddhas 12B Siamese Buddhas and Hari-Hara 12C Prune forest back 12D Replace cedars 12E Restore/reconstruct Vine Walk structure 12F Restore/reconstruct Vine Walk plantings	● ●	● ● ●	●	

**CULTURAL LANDSCAPE TREATMENT PLAN  
ROBERT ALLERTON PARK, MONTICELLO, ILLINOIS**

---

	<i>Structures</i>	<i>Vegetation</i>	<i>Sculpture</i>	<i>Circulation</i>
<p><b><i>Fu Dog Garden</i></b>            13A Conserve/reproduce Fu Dogs            13B Prune Back Forest            13C Replace White Firs            13D Clear opening at south end of Garden</p>		● ● ●	●	
<p><b><i>Lost Garden</i></b>            No capital projects are recommended for this garden</p>				



1. AVENUE OF THE FORMAL GARDENS

---

GARDEN EVOLUTION



**1908 (HGAF-4)** Early view looking northwest along southern section of path developed in 1902 to connect house to formal gardens. Path was initially narrower than it is today and was lined with Irish juniper, yucca and other herbaceous plant materials.



**1908 (HGAF-8)** Two wooden arbors were located near the steps at the middle of the path until 1910.



**1915 (HGAF-17)** The plantings along the path were simplified by 1915, with herbaceous materials and arbors removed. Concrete benches with Korean Fu Dogs behind them replaced the arbors. Junipers and grass continued to line the path along its entire distance, as shown in this view of the southern section looking towards the house.



**1915 (HGAF-18)** This view towards the Rose Terrace shows the northern section of the path, which was more open with turf behind the junipers.



**1925 (HGAF-27)** By 1917 there was a low privet hedge along the northern section of the path (visible in foreground). In 1922 the *Primitive Men* (shown here) replaced the Fu Dogs.



**1940 (HGR-33)** By this time the forest had grown up on either side of the path. In this view along the northern section towards the Rose Terrace, the low hedge is the primary space-defining feature. The upright juniper was replaced with arborvitae and later with yews





**2001** – View looking north away from house. This area has become shady over time, necessitating an adaptation in the plantings. Low curb on left side of path is a post-1946 addition that prevents erosion.



**2001** – View north towards Brick Wall Garden. Compare with 1940 view on previous page, where the arborvitae lining the path provide a very different vegetative character than the current yews.

## **DESCRIPTION**

The area known today as the Avenue of the Formal Gardens was designed in 1902 by John Borie to connect the house and the formal gardens. It is laid out in two segments, with a curvilinear southern half and a straight northern half, broken in between by a set of low steps. Until 1910 there were two rustic arbors situated at the steps, which were replaced by two long benches, one on either side of the path. From 1910 to 1922 there were two Korean Fu Dogs behind the benches, which were replaced in 1922 by the *Primitive Men*, which still remain.

The path was initially narrower than it is today and was lined with Irish juniper interspersed with yucca and other herbaceous plant materials. Plantings were simplified by 1910 with the small herbaceous plantings removed and the juniper remaining the dominant formal element along the entire length of the path.

Over time, as the forest grew up, the junipers were eliminated from the southern section of the path leaving natural woodland with filtered views out towards the lake. The northern section has remained more open, with a wider area of turf beyond the formal plantings. Since 1917 a privet hedge has lined the northern section of the path, separating this formal space from the surrounding area. The junipers along the northern section were replaced by arborvitae and later by upright Japanese yews, spaced further out from the path. The northern terminus of the path is the set of steps leading to the Rose Terrace. There is no 1948 plant inventory for this area.

In summary, the vegetation of this garden has evolved as the surrounding forest has grown up. The southern section has become largely natural in its plantings while the northern section retains some of its formal character.

## **CHARACTER DEFINING FEATURES**

- The central feature of this area is a pea stone path in two segments, divided by a low set of concrete steps. The path was laid out in 1902 and has become wider over time (currently about 13' at the southern end and 9' at the northern end).
- Two flanking limestone *Primitive Men* by Glyn Philpot (since 1922) located on pedestals on either side of the path near the steps.
- Two long concrete benches adjacent to steps (since 1910).
- Upright evergreens lining the northern portion of the path. Initially these were Irish juniper, which lined the entire path. As the surrounding area became shadier, they were eliminated from the southern half. Today upright yews are located along the northern portion of the path.
- Low privet hedge lining the northern section of the path. This hedge, in place by 1917, has varied in height and width over the years. Today it is relatively low and narrow.
- Natural woodland along the southern section of the path.
- Wide panels of turf on either side of the northern segment, with open woodland beyond.

- View south towards house and filtered side views of the pond's upper reaches and the valley.
- Axial view north towards Rose Terrace and Sea Maidens.

### **ISSUES/RECOMMENDATIONS**

The greatest issues facing this garden are those of transitional vegetation management, as the surrounding forest has shaded out the formal plantings, particularly at the southern end. Some adaptations have already been made to accommodate this changing ecology.

The recommended treatment for this area is preservation of extant character defining features much as they exist today, except for vegetation, where a rehabilitation treatment is proposed. This involves adaptations to enhance the natural woodland character along the southern half of the path while retaining a more formal vegetative character along the northern section.

#### **1A. Vegetation at Southern End**

Vegetation that exists today at the southern end includes both ornamental and native species. The recommended approach is to establish a multi-level natural woodland character along the southern section of the path (both sides), using native species to the extent possible. Prune/thin tree canopy to enhance understory. Expand palette of shade tolerant native understory plantings such as native redbud. Remove stockade fencing once dogwoods have become well established. Eliminate narrow turf panel, which is difficult to maintain under shady conditions, replace with pachysandra (which, although not native, has done well in this environment) or other suitable groundcover. Retain low curbing on west side of path or provide less visually intrusive means to prevent erosion on cross-slope. Remove informal path near *Primitive Men*, extend groundcover into this area.

#### **1B. Vegetation at Northern End**

Tree canopy is shading out lawn and yews along the path. The formal planting of evenly spaced fastigate evergreens on either side of the path has been a major feature of this area for nearly 100 years. The recommended approach is to rehabilitate the formal planting along this section of the path, although not using the original species. Selectively remove/prune back tree canopy along northern section to provide adequate sunlight to maintain lawn and formal plantings. Retain low privet hedge along path (20" tall, 24" wide). Replace existing overgrown yews with a fastigate variety. Provide deer protection during winter months. Use historic photos to determine appropriate spacing and distance from path.

#### **1C. Primitive Men**

Retain *Primitive Men* in their current location. Keep forest pruned back above them to eliminate environmental hazards that could damage sculptures. Establish regular cleaning and maintenance program for sculptures and bases in accordance with conservator's recommendations.

#### **1D. Benches**

Benches on west side are leaning against sculpture base and present a potential hazard. Clean and reset benches.

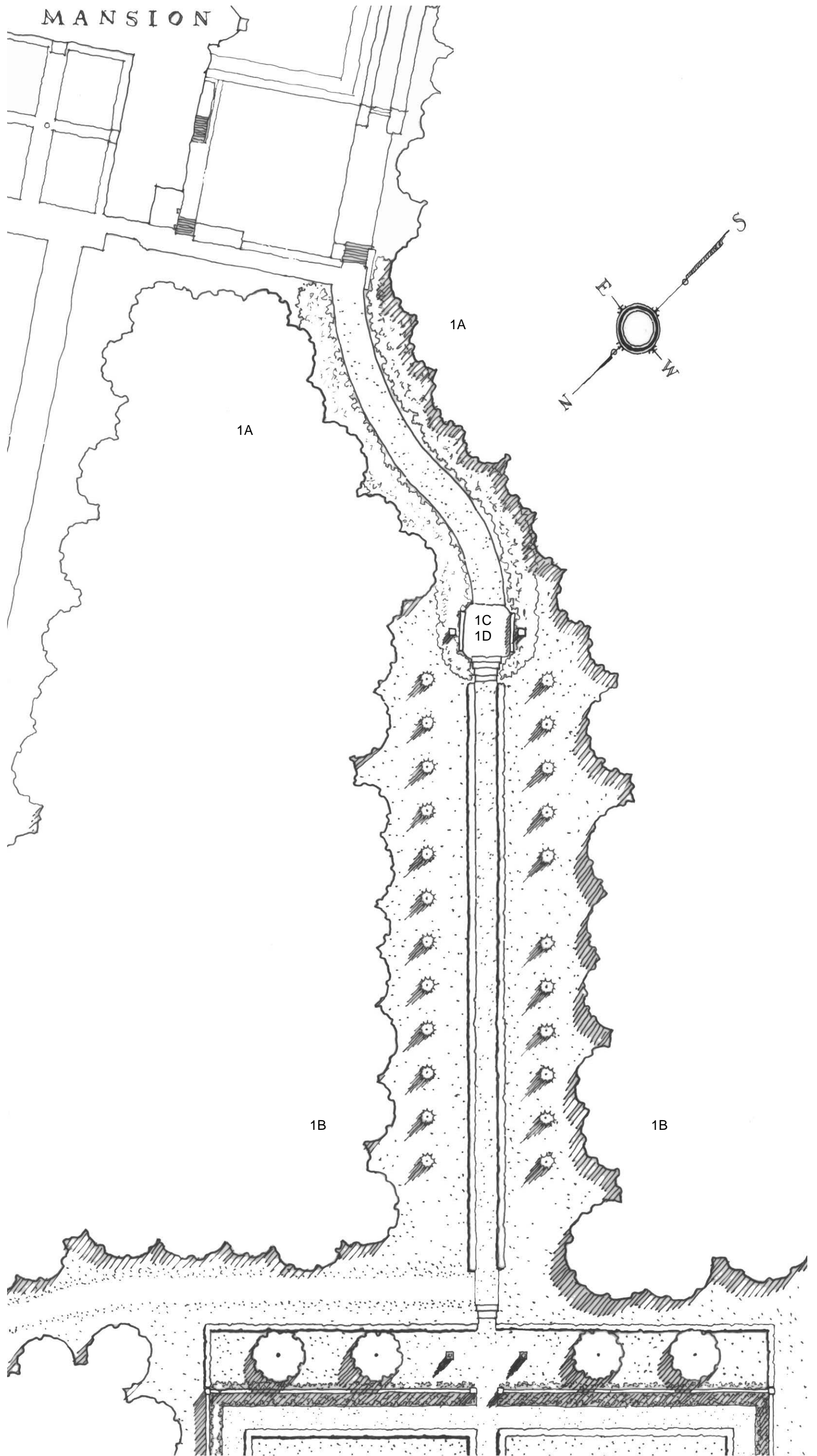

AVENUE OF THE FORMAL GARDENS

40 20 0 50

2. ROSE TERRACE

---

GARDEN EVOLUTION



1908 (HGR-7) Early view showing heavily planted rose terrace with espalier on walls and dual path system with brick edging.



1908 (HGR-11) This view shows the low hedges and fastigate Irish juniper that define the edges of the space. The Borie gates, which were here until 1930, are visible on the far right.





**1920 (HGR-14)** By 1920 the elms in the center beds were well established and the roses had been replaced by more shade tolerant flowers.



**Early 1920s (HGR-17)** The formal hedge-enclosed beds are retained in this view, but the roses have been replaced by other perennials.

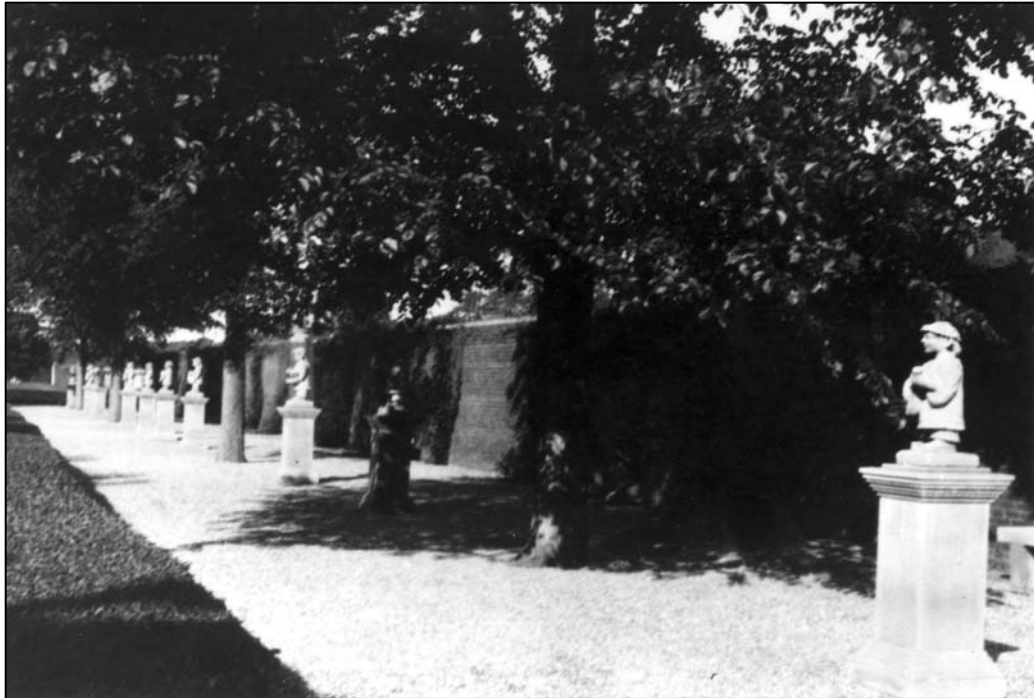

**1925 (HGR-19)** The *Chinese Musicians* shown here were located in this garden from 1925 to 1931. Other features of the garden during this period were the elms, a low privet hedge around the perimeter and the pea stone surface.



**1925 (HGR-20)** View from outside the garden showing steps and perimeter



**1940 (HGR-33)** The *Chinese Musicians* were relocated to the Lost Garden in 1932. The *Sea Maidens* (shown here on either side of the gates) were placed on high columns at the entrance to the Brick Wall Garden in 1935.



**1945 (HGR-35)** Key features of the garden during this period were the *Sea Maidens*, the elms, and honeysuckle on the brick walls, the privet hedge and the gravel path. It had become a shady garden with less detail than the rose garden



**2001** – Compare this current image with that on the previous page taken in 1940. Surrounding vegetation has grown in, particularly on the right, blocking the view of the *Sea Maidens*.



**2001** – John Gregg Allerton’s intended planting of American elms to accompany the *Sea Maidens* has been replaced by arborvitae, which does not create the same effect. Compare with 1945 view on previous page.



## **DESCRIPTION**

The area known at one time as the Rose Terrace was established soon after 1905 when the south wall was added to enclose the Brick Wall Garden. The garden was laid out along the southern face of the wall with a series of narrow rectangular planting beds divided by pea stone paths. The Avenue of the Formal Gardens, which connects the house and the Brick Wall Garden, enters the space at the center, on axis with the entrance to the Brick Wall Garden. Initially the Rose Terrace was a sunny space with showcase formal rose beds and classical urns. Low hedges and fastigiate evergreens defined the perimeter of the garden. Elms were planted at the center of the beds in the late 1910s and low hedges were added around the edges. Gradually the beds became shadier and other herbaceous plantings replaced the roses.

By 1925 the garden was too shady to support flowers so the garden beds were removed and the *Chinese Musicians* were placed on an expanded pea stone surface, creating a much simpler space. When the *Chinese Musicians* were relocated to the Lost Garden in 1932, the *Sea Maidens*, mounted on high pillars designed by John Gregg Allerton, were placed on either side of the south entrance to the Brick Wall Garden, creating a much bolder scale.

The 1948 description of the garden indicates that there were four elms spaced 47 feet apart; six concrete benches, each 5 feet long; 16 groups of Hall's Japanese Honeysuckle supported on strips on wire mesh; and a privet hedge consisting of a double row with the plants spaced 9 inches apart each way, trimmed to 3 feet wide and 26 inches high. Some time after 1948 the elms succumbed to Dutch elm disease and were replaced by the current arborvitae, which give a very different feeling to the garden.

## **CHARACTER DEFINING FEATURES**

- Brick walls (8½ feet tall with concrete capstone), which form the northern edge of the Rose Terrace and the southern edge of the Brick Wall Garden (since 1905) with entrance at center of wall.
- Terrace space approximately 24 feet wide and 232 feet long (since 1905).
- Bisecting path, extension of Avenue of the Formal Gardens, leading from house to Brick Wall Garden (since 1905).
- Two *Sea Maidens* by Richard Kuoll, life-size bronze figures on tall white fluted columns designed by John Gregg Allerton (located here since 1935). Prior to that the *Chinese Musicians* were located here from 1925 to 1931.
- Low perimeter hedge of clipped privet (since circa 1910s). During some periods there were also internal hedges around the various planting beds.
- Plantings: roses (1905 – late 1910s), American elms initially with herbaceous plantings (late 1910s – ca. 1920s); American elms with perimeter hedges and honeysuckle on wall (ca. 1930s – 40s); and more recently just arborvitae and low hedge with strategically placed climbing roses on the wall.
- Low concrete steps which separate lawn from terrace. The first steps were saw-cut limestone slabs.

**ISSUES/RECOMMENDATIONS**

This garden has been through a series of major changes – from rose garden to shady perennial garden to site of the *Chinese Musicians* to site of the *Sea Maidens*. It has gone from a sunny space to a shady space to a sunny space. Today it is a remnant that doesn't reflect the garden's appearance at any time during Allerton's occupancy. The arborvitae are particularly out of character with the intended design for this space.

The recommended treatment for this garden is restoration to the circa 1946 appearance as shown in image HGR-35. This was John Allerton's intended planting to accompany the *Sea Maidens*, which have remained in place here since their acquisition in 1935.

Before replacement plantings are installed, problems with brick walls, which exhibit efflorescence and spalling on the south side, should be resolved. Rebuilding/repair of walls is addressed in conjunction with recommendations for the Brick Wall Garden.

**2A. Plantings**

Current arborvitae are post-1948 replacement plantings, which are the wrong scale and character for this space. Remove arborvitae, including the fifth one on the west side of the Brick Wall Garden, and replace those on the terrace with four disease resistant elms or other species with similar form. Recommended elms include: *Ulmus americana* 'Valley Forge' or *U. americana* 'New Harmon' or *Ulmus parvifolia* 'Allee.' Re-establish honeysuckle along wall as documented in 1948 plant list. Remove Alberta spruce, which do not appear in historic photos. Restore/replace privet hedge in accordance with 1948 description.

**2B. Steps Leading to Rose Terrace**

Existing steps are cracked and risers are inconsistent in height. Rebuild steps concrete to make risers even.

**2C. Sea Maidens**

Retain *Sea Maidens* in this location. Clean and maintain sculptures and columns per conservator's recommendations.

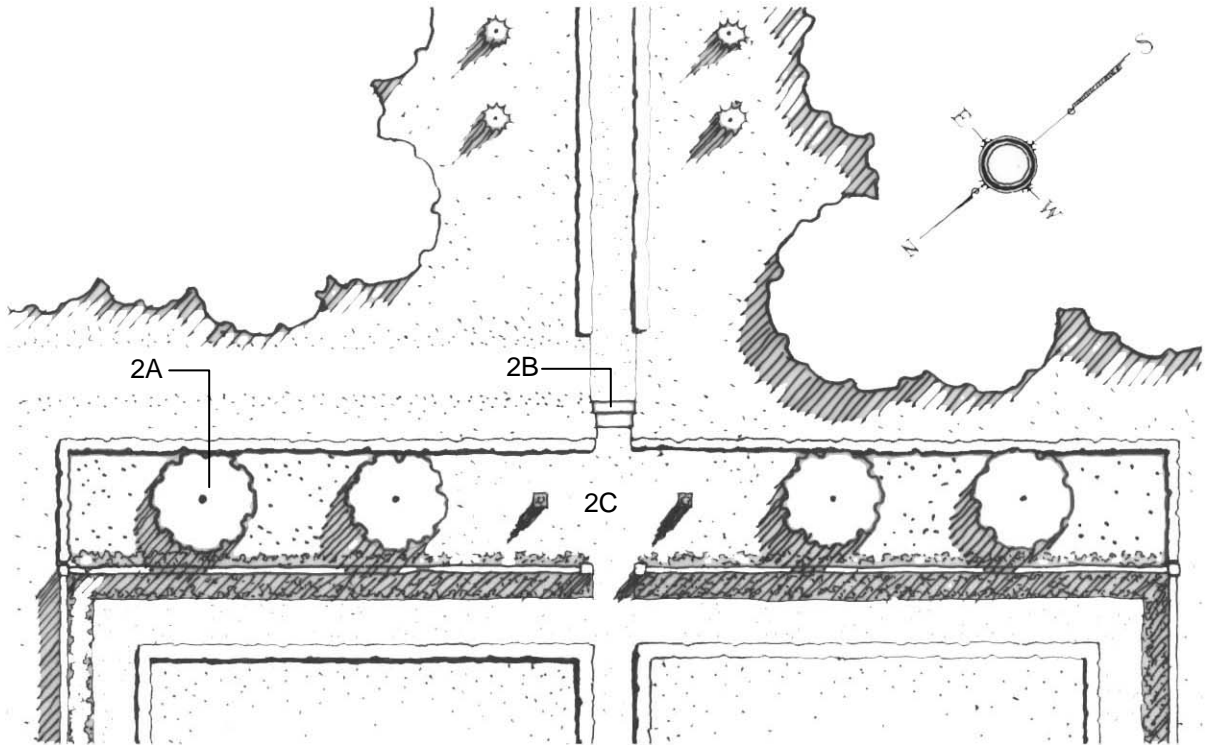

ROSE TERRACE GARDEN

3. BRICK WALL GARDEN

---

GARDEN EVOLUTION



1908 (HGW-5) Vegetables were planted in rows with carrots used along the central path as edging. Eight Irish junipers provided a vertical accent at the center of the garden.



1909 (HGW-21) This garden began as a simple vegetable garden enclosed by a brick wall on three sides. View looking west towards the greenhouse with Borie gates in the



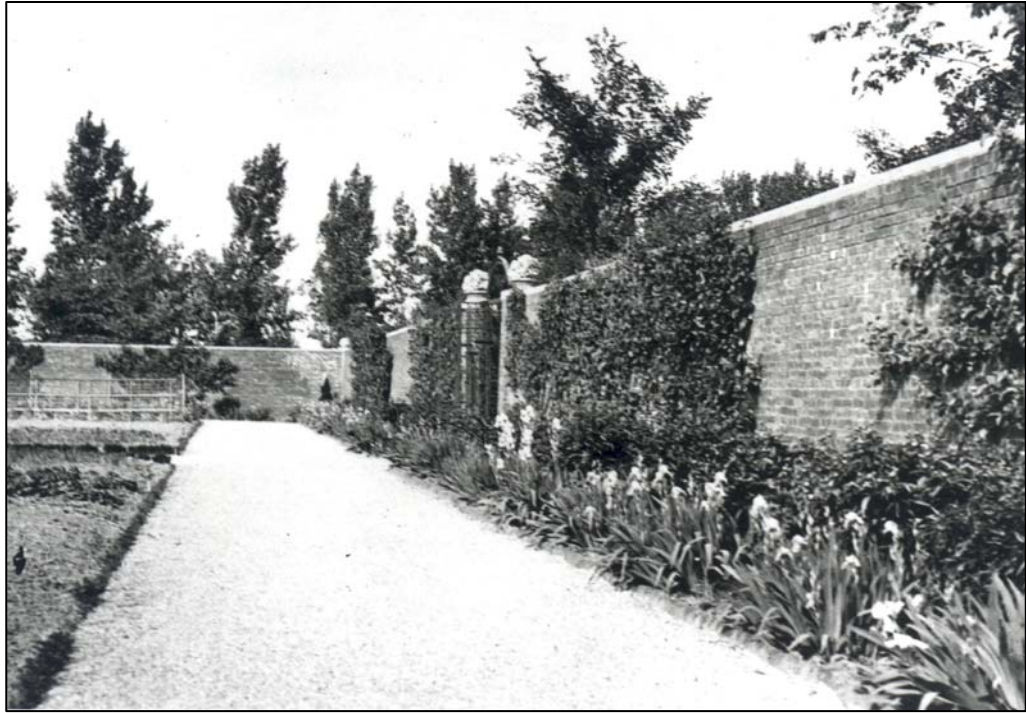

1910 (HGW-14) Flowers and vines were planted around the perimeter when this was a vegetable garden. Note the espaliered fruit trees and brick edging.



1914 (HGW-18) Detail of perimeter planting.



1915 (HGW-23) Borie gates (in foreground) were here from 1905 to 1930. Plantings along paths had become more decorative by this time.

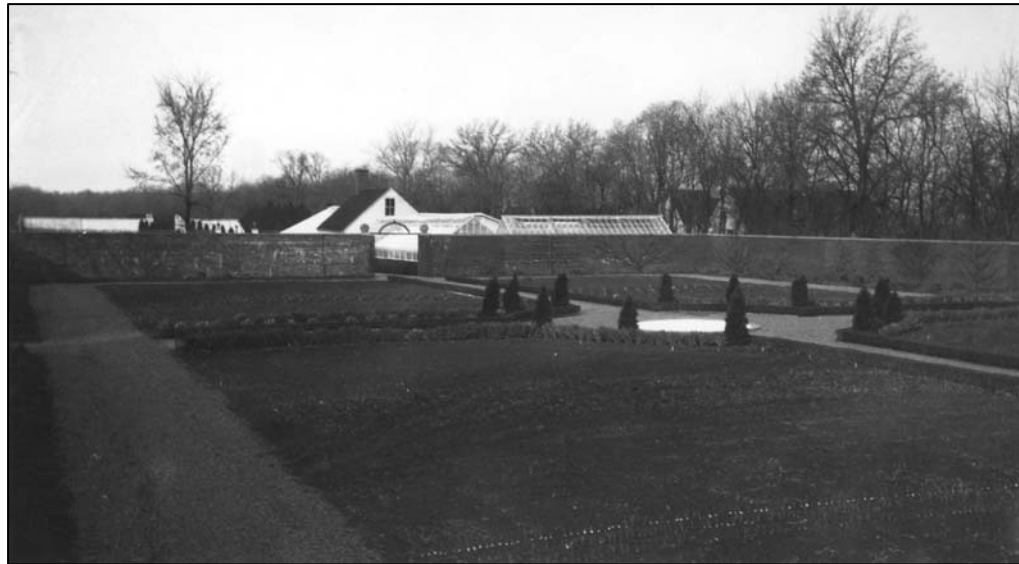

(HGW-26) View of garden in winter showing the basic structure of the space. Note the stark appearance of the garden out of season.



(HGW-33) The carrot border was replaced by privet in the 1920s. The garden was used for vegetables until the early 1940s.



1944 (HGW-45) The *Girl with Scarf* was installed in 1942. Around the same time, the vegetable beds were replaced with turf, similar to what exists today. The Borie gates were relocated to the Chinese Maze Garden in 1930.

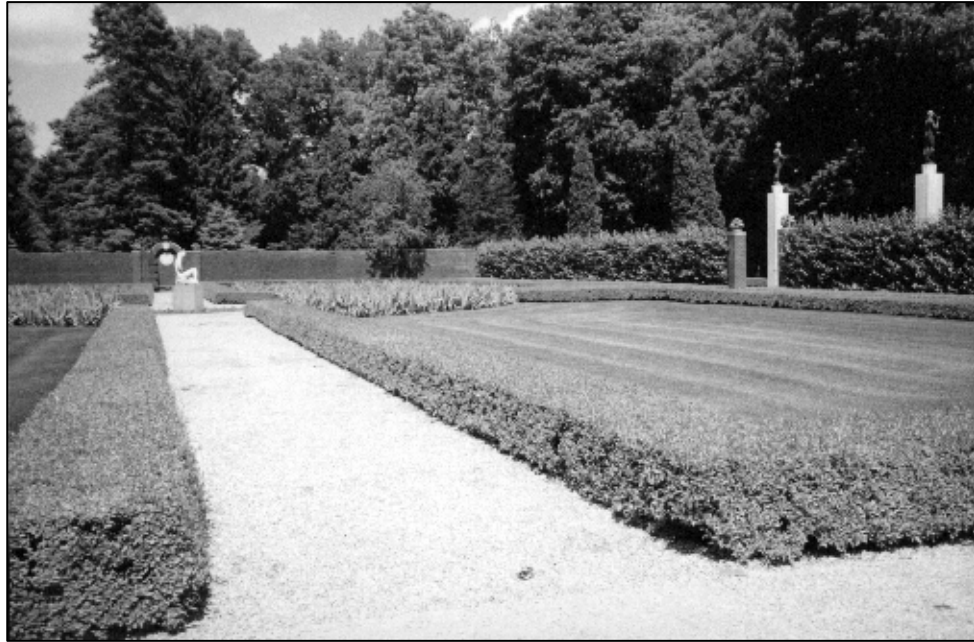

**2001** – View across garden looking east with turf panels in the place of former vegetable beds.



**2001** – This recent view is similar to one taken in 1944 (see previous page) except that ornamental plantings have been added around the central sculpture



## **DESCRIPTION**

The large rectangular Brick Wall Garden, initially designed by John Borie, is surrounded by tall brick walls with entrances in the center of the south and west sides. An earlier entrance at the east side has been filled in and replaced by a decorative niche. A niche is also located at the center of the north wall, although there never was an entrance there. There is a wide pea stone path around the perimeter of the garden and another in a cruciform shape with a circular space at the center. A small irrigation pool was located in this central space until 1933. In 1942 the *Girl with a Scarf* sculpture was placed at the center of the garden, where it remains today.

While the walls and path system have remained largely unchanged for nearly a century, the plantings have evolved over time. The garden initially served as Allerton's vegetable garden, with plants laid out in rows running north/south. Plants such as carrots and parsley were used as edging along the major paths and eight Irish junipers provided a vertical element at the center of the space. Images from as early as 1910 show flowers planted around the perimeter, with vines and espaliered fruits growing on the walls. Although it remained primarily a vegetable garden until the 1940s, the plantings became more decorative along the major paths, with bulbs and flowers added to provide visual interest. By the mid-1940s the character of the plantings had changed dramatically, with vegetables and flowers replaced by turf and low privet hedges. This more formal, institutional appearance has largely been retained, although benches and some irises and other flowering plants have been added at the center of the garden.

The 1948 plant inventory described the espaliers as 27 apples and 7 pear trees trained in a horizontal fashion enclosed by a triple row of Amur River Privet hedges 42" wide and 26" high. The plants in the front row were spaced 9" apart to give a tight appearance while the plants in the middle row and back row were spaced 12" apart in all directions. The four large rectangular beds in the center of the garden consisted of turf panels enclosed by a single row privet hedge spaced 9" apart and trimmed to 30" wide and 18" high.

## **CHARACTER DEFINING FEATURES**

- High brick walls (built 1902-5) enclosing large rectangular garden space. Entrances at center of south and west walls. Niche at northern end since 1902. East door bricked in circa 1984 to form second niche.
- Enclosed rectilinear space approximately 230 feet by 140 feet.
- Pea stone path system (typically nine feet wide) in cruciform shape with central circular space, also perimeter path.
- Four large rectangular garden beds now primarily turf and enclosed by low privet hedges, with circular space at center.
- Narrow planting beds around perimeter, now low privet hedge with espalier behind. These beds have had various plantings over the years.
- Eight carved stone fruit baskets, circa 1905, on top of wall at entrance points.
- Sculpture of *Girl with a Scarf* by Lili Auer, 1942, cement with octagonal pedestal. Installed here 1942 on site of former dipping pool (circa 1901-1935).

- Concrete benches at north and east niches and at center of garden. These were relocated here from the outside walls of the Sunken Garden and were not here in 1946.
- Overhanging trees on the north side provide a visual frame and shelter belt.

### **ISSUES/RECOMMENDATIONS**

The basic structure and spatial organization of this garden have remained intact since 1905. During this time the plantings evolved from a vegetable garden to a low maintenance space with a limited plant palette. In its present form, the garden is not fully representative of its historic appearance, nor does it work well as a public display garden.

The overall philosophy for garden treatment recommended in this report is to preserve the gardens more or less as they appeared in 1946 unless there are compelling reasons to do otherwise. The Brick Wall Garden presents a particular challenge because there were numerous changes in this garden, particularly during the later years of Allerton's occupancy, offering many options for potential restoration or rehabilitation. Appropriate planting treatments could include a range of previous planting conditions that existed in the late 1930s and early 1940s when a variety of combinations of lawns, woody plants, flowers and vegetables were employed.

The recommended approach for the Brick Wall Garden is a rehabilitation treatment that would re-establish some of the visual interest and vegetative diversity that existed in the garden during the later Allerton years. Framework plantings such as the hedges, espaliers and the eight upright trees in the garden center should be retained and/or restored. For flowerbeds, multiple species perennial beds are preferred to single species mass plantings such as the current iris beds. Espalier plantings should be maintained in association with mixed perennial plantings along the walls, and should be pruned regularly to limited their size and density.

Any planting treatment for this garden must include a thorough analysis of capital and operating costs prior to implementation. While re-establishment of a richer planting reminiscent of the garden at its peak is encouraged, such a treatment should be not be undertaken without proper resources for development and high quality maintenance.

#### **3A. Brick Perimeter Walls**

Walls are spalling and in some areas exhibit settling, representing a potential hazard. Repair of perimeter walls must be accomplished prior to any planting. Evaluate previously repaired sections. Walls that have already been stabilized appear to exhibit the greatest spalling, perhaps because of problems with improper capstone flashing. See November 1999 proposal for repairs by Western Waterproofing Company and See "Repair and Rehabilitation Strategies for the Robert Allerton Park Garden Wall," U of I, 1996.

#### **3B. Plantings**

Plantings in this garden do not fully reflect any historic period and do not work well as a display garden. Develop a rehabilitation treatment that meets modern operating needs such as space for special events, and available budget, and also provides visual interest. Such a treatment may include retention and downsizing of the privet hedges; development of perennials and annuals between the brick wall and hedge; replacement of Bradford Pear espaliers with slower-growing, less aggressive dwarf fruit varieties; and the addition of the eight upright evergreens in the center of the garden.

**3C. Sculpture**

Retain Girl with a Scarf and fruit baskets in their present location. Develop regular cleaning and maintenance program based on recommendations of conservator.

**3D. Benches**

Benches provide pleasant opportunities to linger in the space. Retain existing benches at niches and at center of space. Clean and reset as needed, especially leaning west bench.

**3M1. Trees Around Perimeter**

Overhanging trees provide a visual frame and shelterbelt but are also a potential hazard to brick walls and shade out plant materials in the garden. Prune overhanging trees away from walls on north side of garden.

CULTURAL LANDSCAPE TREATMENT PLAN  
ROBERT ALLERTON PARK, MONTICELLO, ILLINOIS

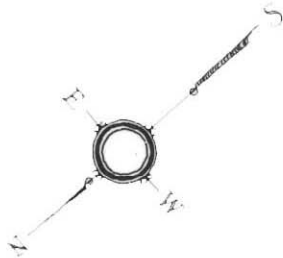
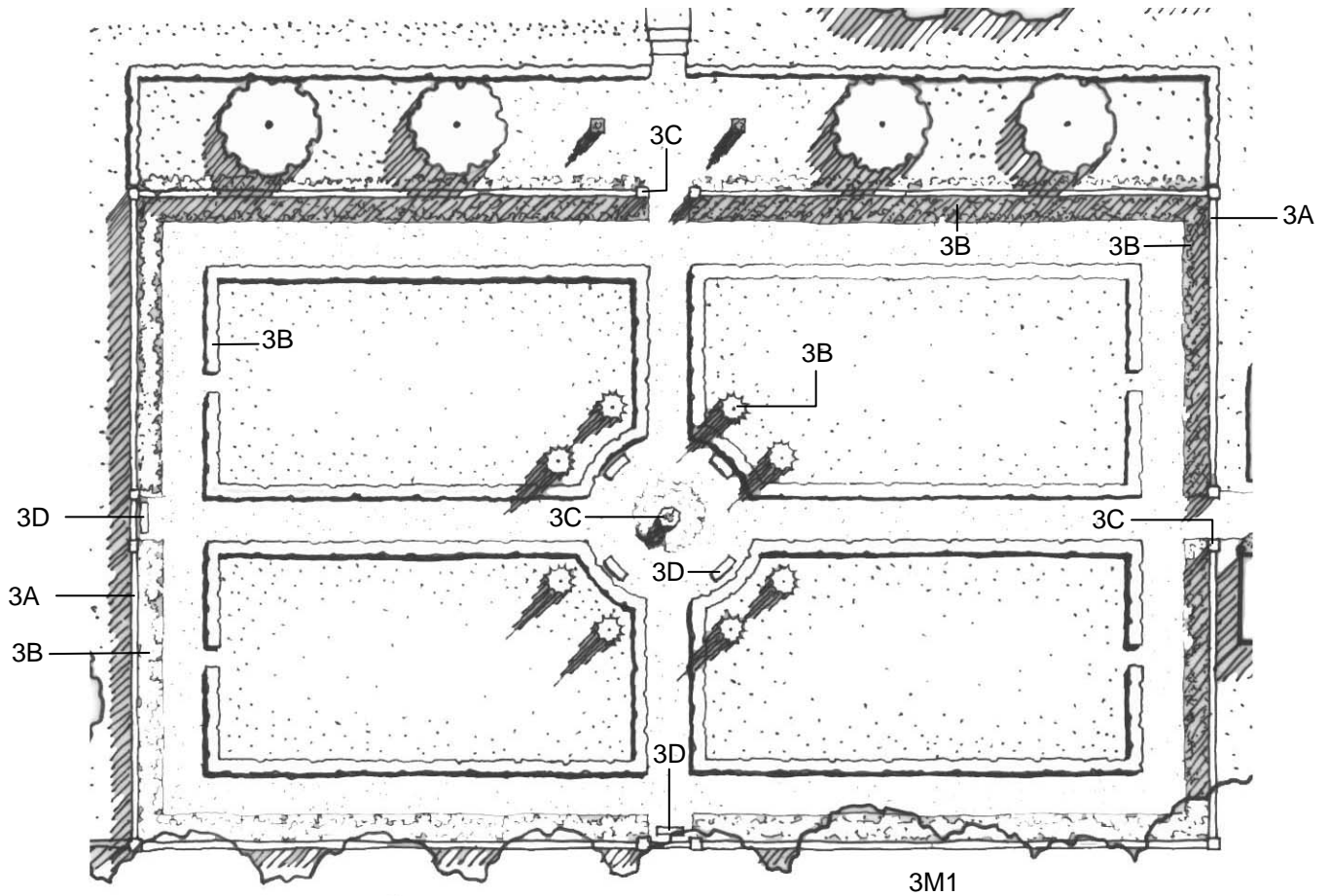

BRICK WALL GARDEN



4. SQUARE PARTERRE GARDEN

---

GARDEN EVOLUTION

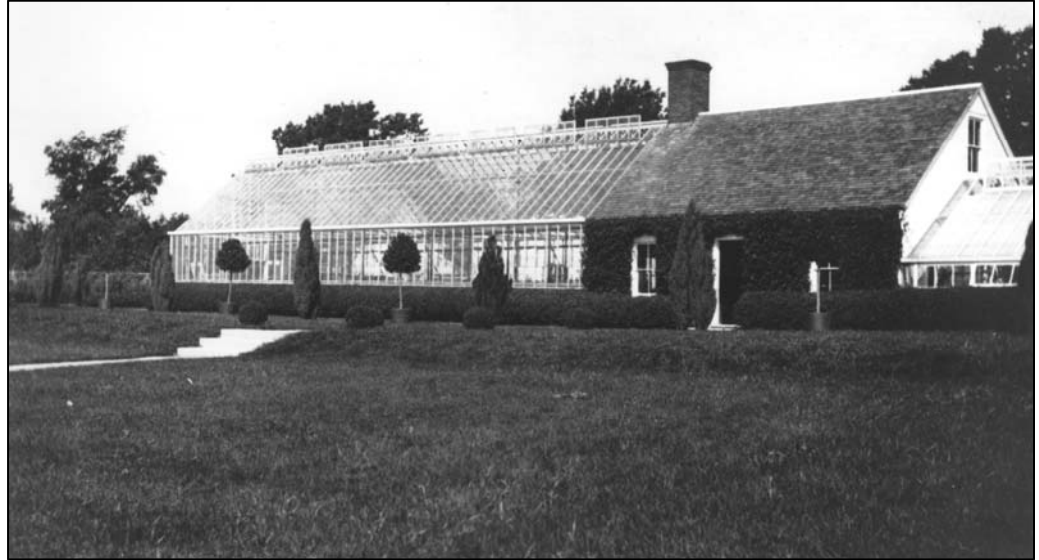

**Circa 1908 (HGHS-2)** This early view shows the garden from the southeast, with north-south path to the greenhouse (at left) and slight drop-off towards the



**1908 (HGHS-3)** This view from the east shows the wide east-west path and greenhouse with low hedge in front, features which have remained largely constant since 1908. The garden itself was not yet established in its present form but instead consisted of alternating fastigiata evergreens, potted topiary and low mound-like plants. Note early view of Triangle Parterre Garden in the background.



**1918 (HGHS-10)** By this date the six square parterres were in place. Hedges were much lower and narrower than they are today. Some squares have an opening at the north side of the outer square, which no longer exists. Sculptures of a shepherd and shepherdess are in second and fifth squares, with mound-like evergreens in center of



**1920 (HGHS-14)** This view is similar to the one taken two years earlier except that it shows the vine trellis along the eastern wall of the triangle parterre garden.

**CULTURAL LANDSCAPE TREATMENT PLAN**  
**ROBERT ALLERTON PARK, MONTICELLO, ILLINOIS**

---



**1925 (HGHS-18)** The major change in this 1925 view is that *Diana* and an *Ephebe* have replaced the shepherd and shepherdess. There are new, more elaborate sculpture bases too. Note the central path and steps at far left, also the path leading to the meadow at the far end of the garden. By this time there is clearly gravel between

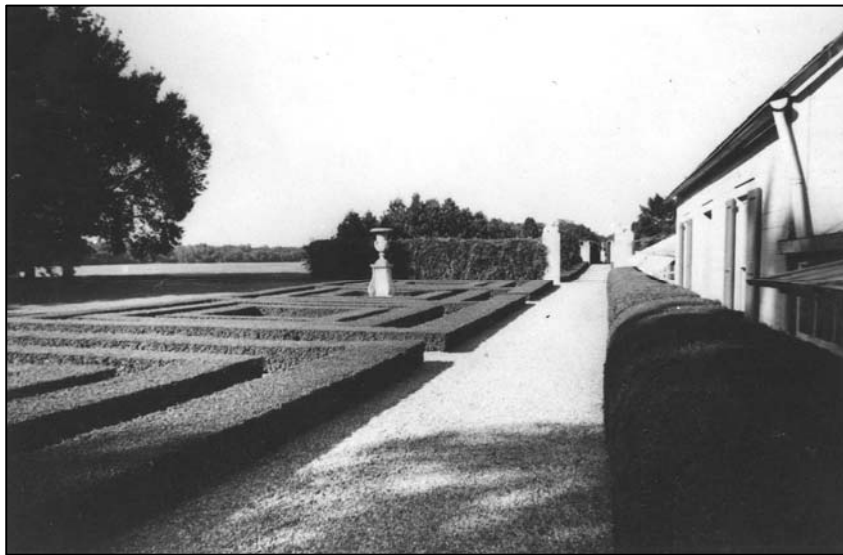

**1938 (HGHS-25)** In 1930 two Baroque urns, one of which is shown in this 1938 view, replaced *Diana* and an *Ephebe* who were moved to the south entrance. Hedges are still fairly low but considerably wider that they were in 1925. Openings in squares at north side have been eliminated. Globe-like evergreens at center of other four beds disappeared by 1935. There is no evidence of annuals in their place. Note view out towards meadow, which remains very similar today.



**2001** – This current view is similar to the 1938 view on the previous page except that parterres have widened in the intervening years.



**2001** – This view towards the west wall shows the spalling of the wall and the paucity of plantings. The single arborvitae is a post-1946 addition.



## **DESCRIPTION**

The Square Parterre Garden (also known as the Hedge Maze Garden) began around 1902 as a narrow path adjacent to the greenhouse. Plantings were added around 1908 when topiary and potted plants were placed along the southern side of the walkway. By 1918 the six square hedge parterres were in place, although much lower and narrower than they are today. The garden has been altered relatively little since it was established, except for changes in statuary. The urns currently in the garden have been in place since 1930.

The 1948 plant list describes the privet hedge against the greenhouse as two rows of plants set 12 feet apart each way, about 44 feet high with the front rounded off. The hedge in the squares is described as 15 inches high, with most of it 30 inches wide and planted in a single row 9 inches apart. The hedge around the northwest side and both ends of the garden proper was in a double row spaced 9 inches apart and trimmed to a 40-inch width. The gravel paths inside the squares were 18 inches wide while the centers of the squares were open and 9 feet by 9½ feet wide with urns in the center. There were a total of about 2,251 privet plants in this garden. The brick wall at the east end of the garden was planted with eight grape vines and three Hall's honeysuckle vines twining up a strip of woven wire fencing. There was also a large American elm at the southwest corner.

This garden functions as a connecting space between the Brick Wall Garden, and the Triangle Parterre Garden. Unlike most of the other gardens it is not fully enclosed but is open to the adjacent meadow with spectacular views to the southwest. It is simple and understated in form with the green hedges and white urns as the primary focal points. Climbing roses are currently planted along the east wall and wisteria on the trellis at the west end of the garden, with hosta below. In 2000 minor regrading was done to eliminate the steps at the south end of the garden to accommodate ADA.

## **CHARACTER DEFINING FEATURES**

- Six square planting beds of clipped Amur River privet, each consisting of three squares inside each other. See 1948 description above.
- Wide central path of exposed aggregate concrete (which replaced pea stone in 2000) linking with other formal gardens. Secondary north/south paths leading from greenhouse entrance to meadow and along west side of garden.
- Greenhouse/visitor center, which forms northern edge of garden.
- Brick wall (rear of Brick Wall Garden), which forms eastern edge of garden. In 1948 this wall was planted with grape vines and honeysuckle. Currently planted with roses that are not doing well.
- Wire vine wall, which forms western edge of garden. In 1948 this wall was planted with wisteria and honeysuckle. Today only the wisteria remains, with some herbaceous plantings below.
- Statuary in center of two mazes (initially shepherd and shepherdess, after 1925 *Diana* and *Ephebe*, since 1930 two Italian style limestone urns on elaborate pedestals).

- View southwest through open woodland towards meadow and southeast towards house.
- Views east into Brick Wall Garden and west along central path.

**ISSUES/RECOMMENDATIONS**

This garden has a high level of historical integrity, with few changes occurring since it was established other than changes in statuary. Preservation of existing features is the recommended treatment, with minor changes to restore historic appearance of vegetation.

Before replacement plantings are installed on the west wall, problems with brick walls, which exhibit efflorescence and spalling, should be resolved. Rebuilding/repair of walls is addressed in conjunction with recommendations for the Brick Wall Garden.

**4A. Privet Hedges**

Maze hedges have become substantially wider than they appear in historic photographs. Restore size and shape of hedges to their circa 1948 appearance (see photo HGHS-25). Install weedmat and new gravel. Retain hedge along greenhouse at current size. Eliminate annuals in center of beds, which are a recent addition.

**4B. East Wall Plantings**

Replace roses along east wall with honeysuckle and grapes that existed in 1948.

**4C. West Vine Walk Plantings**

Retain wisteria. Reestablish honeysuckle that existed in 1948.

**4D. Sculpture**

The two urns in the center of the parterres are in extremely poor condition and continue to deteriorate. They need to be recarved and replaced, with the originals stored indoors. (See 1994 Forsythe survey for specific treatment recommendations.)

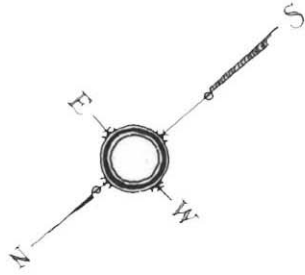
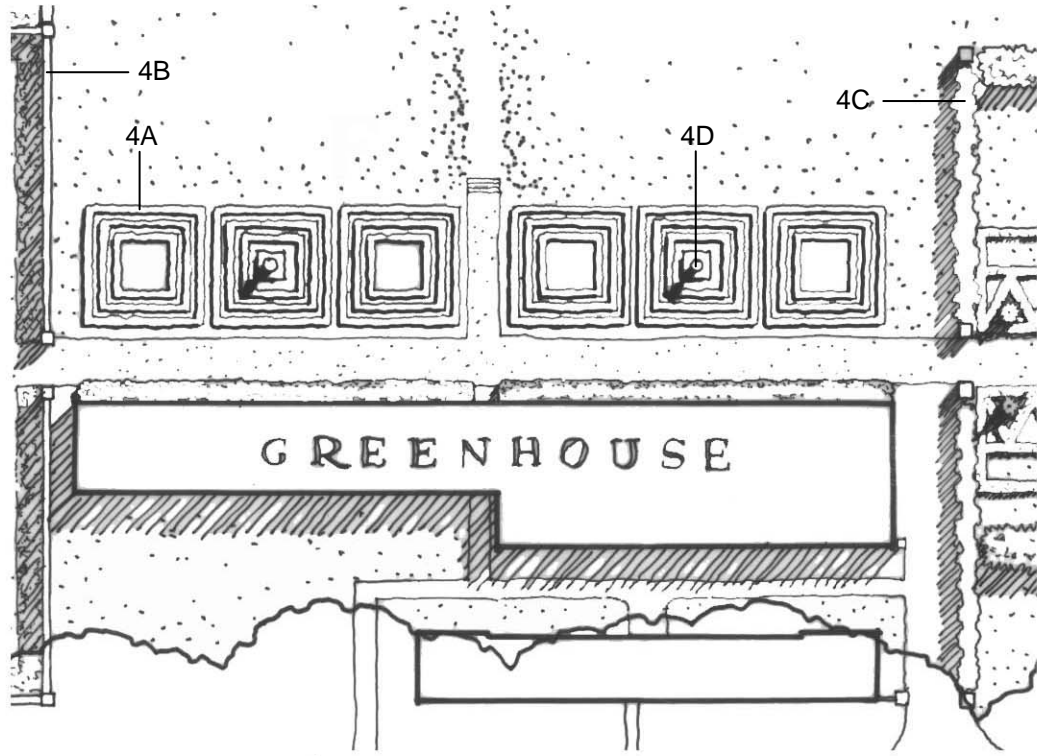

SQUARE PARTERRE GARDEN

5. TRIANGLE PARTERRE GARDEN

---

GARDEN EVOLUTION



1908 (HGTO-1) Gravel path through center of space, lined with evenly spaced Irish juniper. Rows of very low herbaceous plant materials behind. Loose low hedge at outer edges of garden. Sweet corn was grown in the beds behind.



1910 (HGTO-2) View from northeast corner showing low hedge between Irish juniper at far left, rows of herbaceous plantings behind juniper, and single row of arborvitae at right. Sweet corn plants are gone.





1914 (HGTO-3) View looking east along center path with low, loose hedges (which appear to be unsheared privet) between the Irish junipers.



1930 (HGTO-6) The columns at the east end of the garden (foreground) were added by 1918 (see HGHS-10). The adjacent trellises and wisteria were added by 1920. *Assyrian Lions* were added on the pillars at the west end of the garden in 1922. Sometime between 1925 and 1930 the triangular beds were laid out, with gravel used inside the hedges to create patterns. This 1930 view shows ornate garlanded lead urns on top of the east columns and wisteria growing profusely on the trellises. *Arborvitae* have replaced the Irish juniper by this time.



**1935 (HGTO-9)** This 1935 view shows the central portion of the garden much as it exists today. Although not visible in this photo, replicas of the *Assyrian Lions* were placed on top of the east columns in 1935. The lions at the west end of the garden were replaced with replicas in 1976. The arborvitae lining the path have been replaced several times when they were overgrown and damaged by an ice storm.

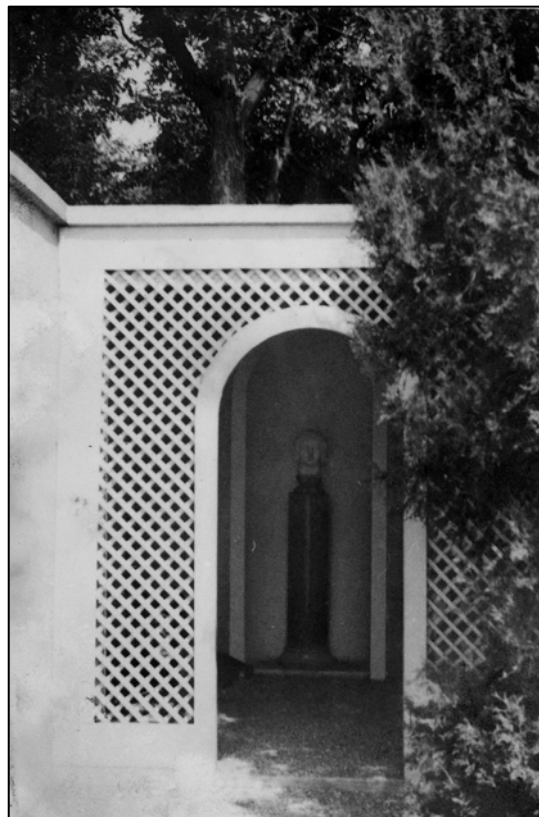

**1930s (HGHS-1)** View of original stair tower at northwest corner with a basalt bust. The current structure is a 1985 replacement, which is not an accurate replica.



**2001** – The arborvitae lining the main path have grown out of scale with the intended look of the garden. Compare with earlier photos.



**2001** – Annuals such as the marigolds shown here do not appear in earlier photographs.

## **DESCRIPTION**

The Triangle Parterre Garden began around 1908 as a simple garden path lined on either side with fastigiata Irish juniper to provide a vertical element in the horizontal landscape. Sweet corn was planted at the outer edges of the garden. By 1910, low hedges linked the junipers, and arborvitae screen plantings were planted at the north and south edges of the garden, giving it a more enclosed appearance. By 1922 these juniper were replaced by arborvitae and the triangular parterres were laid out with perennial plantings behind. Additional rows of arborvitae screening were added to front those limbed up by shade.

The garden is a continuation of the formal pathway connecting the Square Parterre Garden on the east with the Annual Garden to the west. It is framed by high concrete walls at the west end. Wire trellises planted with vines form the northern, eastern and southern boundaries of the garden, although the arborvitae form the visual edge on the north and south sides. Sculptures of *Assyrian Lions* are located on top of the columns at the eastern and western entrances to the garden and there is a small stair tower at the northwest corner, which provides access to the wall walk that runs along the northern edge of the Annual Garden. The basic structure of the garden as it exists today was intact by 1925 and has changed relatively little since then, other than that the arborvitae have become more overgrown.

The 1948 garden description indicates that the garden is 132 feet wide by 232 feet long and provides a detailed description of the vine trellis construction. The vine trellis at the east end was covered with 32 plants of *Wisteria macrostachya* and numerous vines of Hall's Japanese honeysuckle (*Lonicera japonica* 'Halliana') and Chinese Japanese honeysuckle (*Lonicera* var. *chinensis*). The central walk was bordered by a double row of privet hedges with the plants spaced 9 inches apart, 12 inches between rows, and pruned to 30 inches wide and 18 inches high, with a similar hedge placed 6' behind. In every other triangle was a pyramidal Eastern arborvitae (*Thuja occidentalis* *pyramidalis*) of which there were 18 total. A privet hedge located 5 feet behind the last one and comprised of a triple row with the plants spaced 12 inches apart was pruned to 40 inches wide by 27 inches high. In front of this last row of privet was a row of August lilies (*Lycoris squamigera* pseudonym *Amaryllis hallii*) spaced 12 feet apart (444 total). Behind the privet were 19 plants of Adams needle (*Yucca filamentosa*) at irregular intervals. The north border of the garden was formed by a row of 17 Oriental arborvitae (*Thuja occidentalis*) spaced 12 feet apart with a row of Ware Eastern arborvitae (*Thuja occidentalis* 'Wareana') spaced 6 feet apart each way. The south side of the garden had four rows of Ware Eastern arborvitae (140 total) spaced 6 feet apart.

## **CHARACTER DEFINING FEATURES**

- Wide central path of exposed aggregate concrete (which replaced pea stone in 2000) linking with other gardens. Secondary narrow north/south path at west end of garden.
- Evenly spaced vertical evergreens lining the path, initially Irish juniper and since about 1930, fastigiata arborvitae.
- Small triangular beds of tightly clipped Amur privet lining either side of the main path, with narrow rectangular beds behind (since about 1925).
- Perennials behind triangle parterres on either side of the path. These included yucca and August lilies.



- Multiple rows of Thuja occidentalis ‘Wareana’ north and south of main walk forming the visual boundary to the garden, giving it a narrow appearance.
- Trellis wall (north, east and south) built 1920. East side planted with wisteria.
- Wooden stair tower (original built 1920, current one is a slightly smaller 1985 replacement, patterned after the Lost Garden pavilion) with sculpture inside.
- Square pillars at east and west ends of garden. Assyrian Lions were placed on west gateposts in 1922. Initially there were garlanded lead urns and orb finials on the east columns, which were replaced with copies of the Assyrian lions by 1935.

#### **ISSUES/RECOMMENDATIONS**

While the basic structure of this garden is intact, much of the plant material is overgrown, especially the arborvitae along the main path and at the north and south sides, destroying the intended appearance of the space. The recommended approach for this garden is to retain the garden structure and to replace overgrown vegetation to restore design intent.

The stair tower at the northwest corner was designed for personal use by Allerton and his guests. Even with modifications the catwalk would not be appropriate for public use. Access should be permitted for staff only. There was some staff interest in extending the concrete wall east along the northern edge of this space to screen vehicular traffic but this idea did not receive general support.

#### **5A. Triangle Parterres**

Parterres are the central feature of this garden and have a high level of integrity. Prune parterres to 1948 height and width. Install weedmat and new gravel. Eliminate annuals in bed behind triangles.

#### **5B. Arborvitae in Triangles**

These are too large relative to the size of the parterre hedge. Replace with a narrower, more compact variety of arborvitae or a smaller species of narrow upright evergreen. Ultimate height should be only slightly higher than that of the columns on which the Assyrian lions are mounted.

#### **5C. Arborvitae, North and South Edges**

Remove deteriorated arborvitae screen planting at north and south edges of garden. Replace with screen plantings that existed in 1946. Prune adjacent Osage orange hedge between garden and road to provide suitable growing conditions for arborvitae at north edge. The new arborvitae should be maintained at a height no greater than 24 feet.

#### **5D. West Wall**

Retain espalier. Remove herbaceous plantings below and extend gravel to face of wall.

#### **5E. Stair Tower**

Modify existing ogee-arched entrance to replicate the original half-circle arch. See image HGHS-1.

**5F. Sculpture**

Establish regular cleaning and maintenance program for Assyrian Lions. Provide more accurate replacement sculpture in stair tower.

**5G. Foundation at North Side**

Remove this 1947 foundation constructed by the University of Illinois that serves no useful purpose.

**5M1. Trees Around Perimeter**

Overhanging trees provide a visual frame and shelterbelt but are also a potential hazard to concrete walls and shade out plant materials in the garden. Prune overhanging trees away from walls on north side of garden.

CULTURAL LANDSCAPE TREATMENT PLAN  
ROBERT ALLERTON PARK, MONTICELLO, ILLINOIS

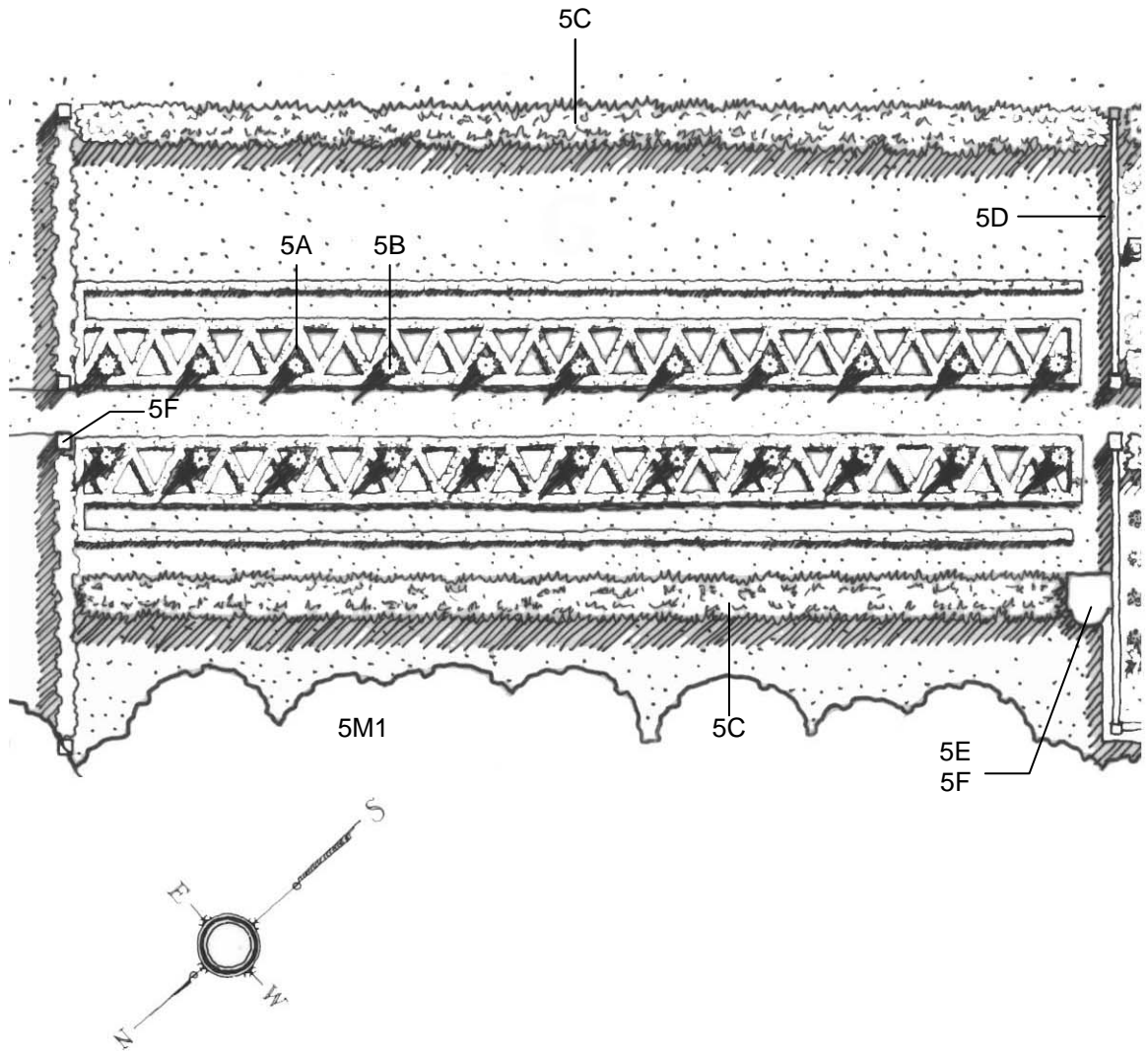

TRIANGLE PARTERRE GARDEN

**6. FLOWER GARDENS – OVERVIEW**

*The Flower Gardens consist of three separate floral display gardens: Peony Garden (spring), Bulb Garden (summer), and Annual Garden (fall), which collectively form one larger garden. The central allee of arborvitae and Adam, comprise the winter display. These gardens are addressed individually and collectively, beginning with a summary of general issues.*

**GARDEN EVOLUTION**



**1917 (HGFO – 4)** View along main pathway of Flower Gardens, looking west towards Chinese Maze Garden.



**2001** – View of same path today with replica Adam at the cross axes.





**1925 (HGA-25)** This detail slide illustrates the level of refinement and careful maintenance that existed under Robert Allerton's stewardship. While the structure of the flower gardens remains intact, loss of detail, overgrown plant materials and lack of species diversity in the ornamental plantings have changed the overall effect.

#### **CHARACTER DEFINING FEATURES FOR FLOWER GARDENS AS A WHOLE**

- Long, narrow rectangular space roughly 560 feet long by 130 feet wide, sub-divided into four smaller rectangular garden spaces.
- Main east/west path through center of gardens. North/south path near eastern end of garden. Another north/south path along western edge of garden.
- Sculpture of *Adam, The Creation of Man* at intersection of two main paths. Current *Adam* is a 1972 second-generation copy.
- Clipped arborvitae hedge lining central path, originally single row, since 1960s a staggered a double row.
- High rough-finished concrete walls, originally smoother finished and vine covered, along northern, eastern and western edges of garden, with viewing platform along outer edge. Unclipped arborvitae along southern (meadow) edge.
- Views out to the south at two north/south paths. View along the east/west path framed by arborvitae hedge with *Adam* as a focal point.

#### **ISSUES/RECOMMENDATIONS**

The Flower Gardens retain their basic form and structure, but plantings have evolved over time, losing the details, intricacy, scale of plantings, species diversity and meticulous maintenance that gave the gardens their visual impact and distinctive character. The primary recommendation for the Flower Gardens is to restore missing detail to increase visual interest in these spaces.

**6A. Concrete Walls**

Recent studies of the concrete garden walls by University of Illinois students have indicated that while there is evidence of problems such as spalling, disintegration, corrosion, cracking, discoloration and biological growth, the walls are still structurally sound and can feasibly be repaired and cleaned. See “Repair and Rehabilitation Strategies for the Robert Allerton Park Garden Wall,” U of I, 1996 and “Historic Concrete Repair Investigation at Robert Allerton Park, Part I,” by Amy Lamb Woods, U of I, 2000 as well as November 1999 proposal for repairs by Western Waterproofing Company.

**6B. Adam**

Muriel Scheinman, who compiled a catalog of art at the University of Illinois, described the current Adam, a second-generation copy, “It looks crude and unfinished and lacks artistic fidelity.” A more precise replica of the original Adam should eventually replace the current version.

**6C. Arborvitae Along Central Walkway**

Current double staggered row (which dates the to the 1960s) obscures view of gardens from main walkway. Existing arborvitae are in good condition and do not need replacement. However, when replacement is needed in the future, use a single row that will grow to appropriate scale at maturity (no higher than the adjacent wall) do not shear.

**6D. Hedge Along Southern Edge of Garden**

Many of the arborvitae along the southern edge of the garden have been removed and those that remain are split and leaning. The sense of enclosure has been lost and the garden is now open to deer. Remove existing arborvitae and replace arborvitae along southern edge of Bulb Garden. Maintain at approximately the same height as the stone walls surrounding the rest of the flower gardens.

**6M1. Trees Around Perimeter**

Overhanging trees provide a visual frame and shelterbelt but are also a potential hazard to concrete walls and shade out plant materials in the garden. Prune overhanging trees away from walls on north side of garden.

6A. FLOWER GARDENS – PEONY GARDEN

---

GARDEN EVOLUTION

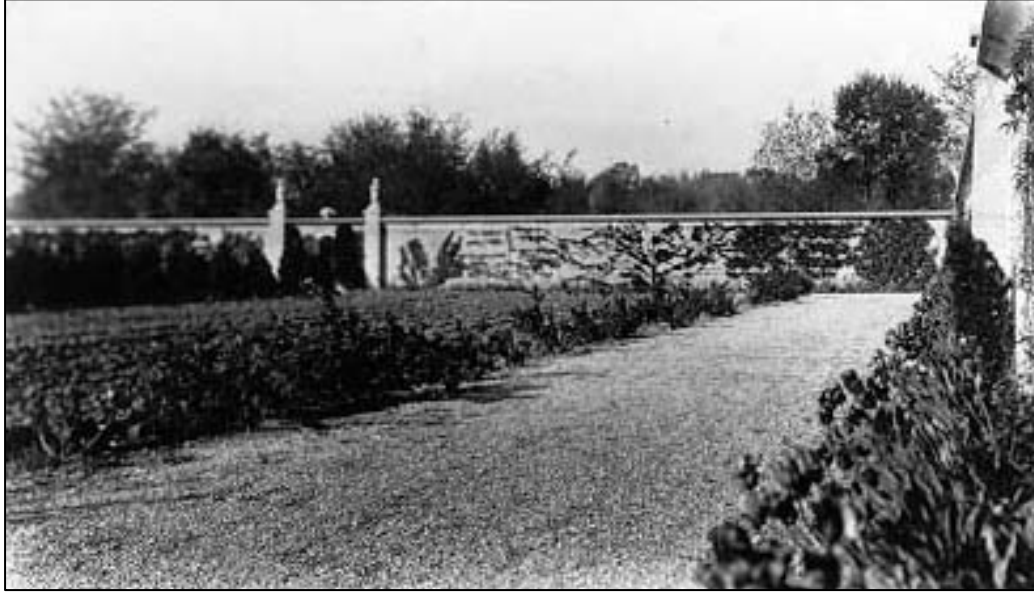

1915 (HGHF-4) Early view of peony garden looking southwest, with well-established espaliers and multi-season plantings along north wall.



1918 (HGHF-6) View west along northern edge of garden with tree and irises. Note screening on wall to support vines, which were intended to cover the wall.



1925 (HGHF-15) View from catwalk showing peonies interplanted with irises, which were later replanted to the border as the blooming sequence was too close to that of the



1935 (HGHF-32) View west showing peonies in bloom. Nothing appears to be interplanted at this time although there is a border of irises along the northern edge of the peony bed.



2001 – View of peony garden from roof of stair tower in Triangle Parterre Garden.  
The *Three Graces* were not placed here until 1970.



2001 – View of Peony Garden looking west with irises in the foreground.

## **DESCRIPTION**

The Peony (spring) Garden, which runs along the entire north side of the Flower Gardens, consists of two long narrow rectangular spaces broken by a path about one third of the way along. The garden is enclosed on three sides by high concrete walls and on the south by a double row of arborvitae. The primary feature of the garden is a peony varietal bed of colorful and monumental scale, with peonies in a diagonal pattern, interspersed with sedum, which has been added to provide fall interest.

The 1948 plant inventory identified 33 varieties of peony interplanted in a diagonal pattern with Sedum spectabile spaced 4 feet apart in the row and 5 feet between rows. A double row of light blue German Iris (bearded) (Iris X germanica – cultivar unknown) was used to border the peony beds. The north wall was planted with 127 blue grape vines (Vitis sp.) intermixed with Moonseed (Menispermum canadense) and underplanted with tulips (Tulipa, cultivar unknown).

## **CHARACTER DEFINING FEATURES**

- Long narrow rectangular space subdivided into two smaller spaces.
- Bold, dramatic planting of alternating peonies and sedum in diagonal pattern.
- High concrete walls with rough finishes enclosing the garden on the east, north and west. The espaliered grapevines that previously covered the walls, and spring bedding borders, have largely disappeared.
- Arborvitae hedge along southern and western edges of garden and on either side of north/south path into garden.
- East/west path running along the northern edge of the garden, with two secondary north/south paths.
- Niche and bench south side of wall at major north/south path.

## **ISSUES/RECOMMENDATIONS**

This garden retains its basic form and structure but plantings have become less diverse over time, with plantings along the wall almost entirely missing. The current appearance of the garden is far less intricate and seasonally interesting than it was in Allerton's time. The recommended approach is to restore plantings to their circa 1946 appearance.

### **6E. Plantings on Walls**

The unfinished concrete walls were intended to be covered with grape and moonseed vines, with bulbs below. Restore wall plantings.

### **6F. Peonies**

Peonies, iris and sedum are formal plantings that can only reach full impact when they receive adequate high-quality maintenance. Re-establish diversity of peony varieties to the extent feasible and provide adequate maintenance to ensure the effectiveness of this bold, simple space as a display garden.

**6G. *Three Graces***

This sculpture was placed here in the 1970s. It is inappropriate in the Peony Garden and should be relocated to its original site or placed in storage until an appropriate location can be found.



6B. FLOWER GARDENS – BULB GARDEN

---

GARDEN EVOLUTION



1935 (HGFB-3) View of the bulb garden in its prime, with 105 alternating rows of summer bulbs. Spring bulbs were primarily daffodils, narcissus and jonquils.

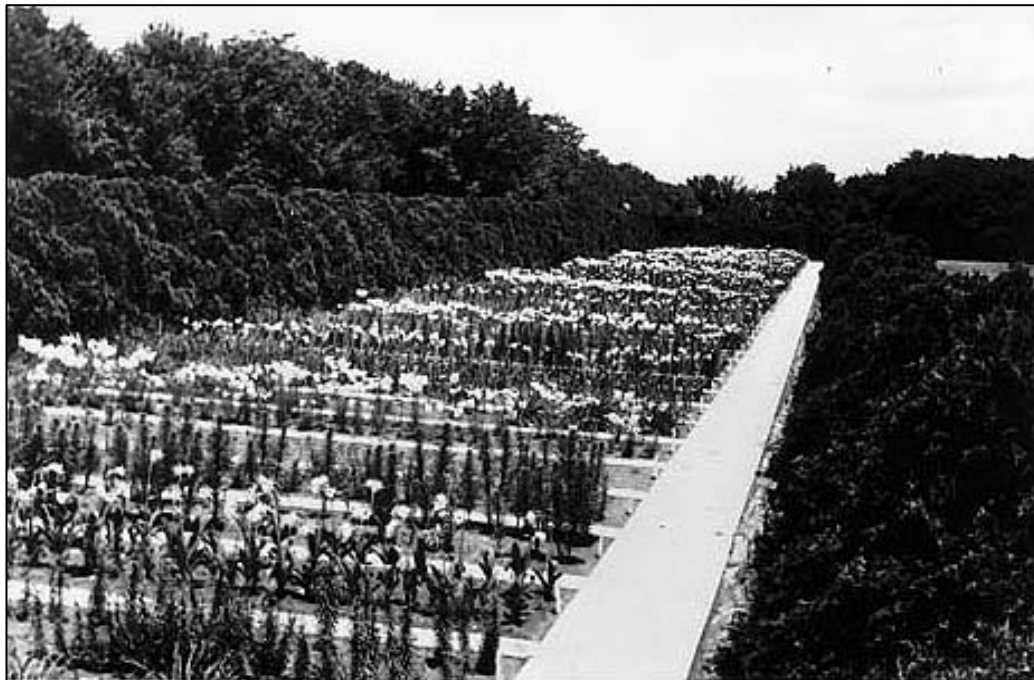

1937 (HGFB-5) The walkways and varied textures evident in this image show the intricacy that is somewhat lacking in the garden today.





**2001** – Today the Bulb Garden is much simpler than it was during Allerton's time, with less intricate plantings and path system.

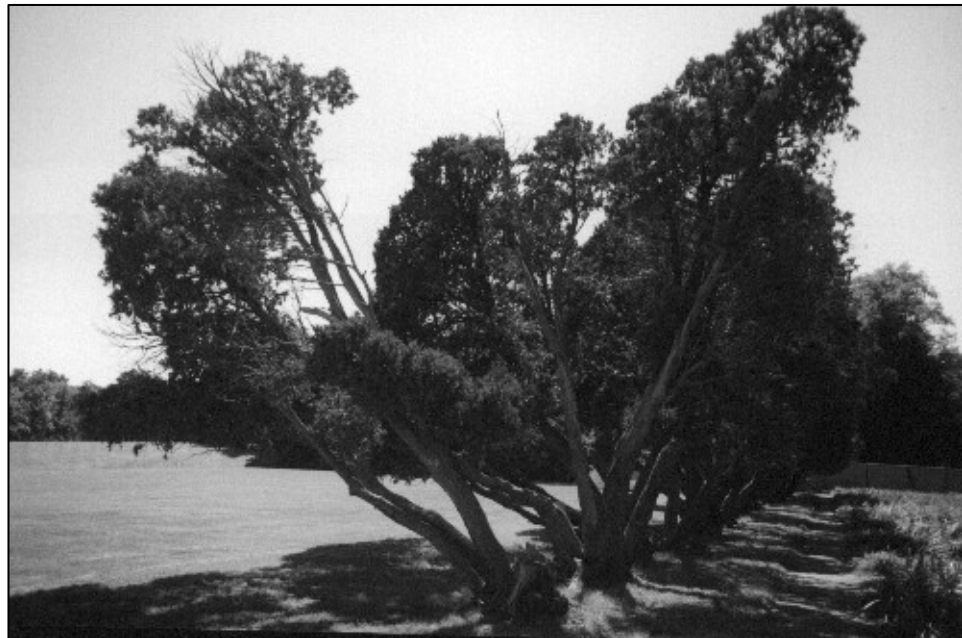

**2001** – The cedars that form the southern edge of the garden are over mature and have suffered from storm damage.

**DESCRIPTION**

The Bulb (summer) Garden is a long narrow rectangular space, roughly 385' long by 40' wide surrounded on three sides by clipped arborvitae hedging and on the fourth by an overmature cedar hedge. Flowerbeds run north/south in narrow single species rows in which seven species of bulb plants are repeated fifteen times. During the late spring and early summer the garden has a colorful display of flowers. In late summer and fall, the texture of the foliage presents a subtler garden. There is an exposed aggregate concrete walkway running along the southern edge of the garden.

The 1948 plant inventory describes a succession of bloom created throughout the growing season by the use of 14 varieties of daffodils, 23 varieties of tulips, dwarf peonies, Oriental poppies, white Japanese iris, Umullatum lily, false alae, light blue bearded iris, regal lily, tiger lily, Henryi lily, dwarf evening primrose, and August or Resurrection lily, with rows of different kinds of plants inter mixed at random. Later in the year various types of annuals were introduced to add color after the bulbs had reached their peak. *Amaryllis hallii* was planted along the southern edge of the garden.

**CHARACTER DEFINING FEATURES**

- Tall clipped arborvitae hedges on three sides, with unclipped cedars on the south.
- Short alternating rows of flowers running north/south with seasonal display of flowers in late spring/early summer.
- Concrete path running along southern edge of garden.

**ISSUES/RECOMMENDATIONS**

This garden retains its basic structure but only remnants of the once elaborate plantings remain, causing the garden to lose its much of its intended character. Some of the rows of bulbs are almost totally depleted, destroying the visual impact that the garden had in its prime. Recommendations for this garden focus on restoring missing or deteriorated features. Replacement of the cedars along the southern edge is addressed in the overall discussion of the flower gardens.

**6H. Plantings**

This garden is attractive during its peak season but of less interest to visitors during the rest of the year. Restore multi-season bulb and annual plantings, based on 1948 plant list and improve garden maintenance. Replace arborvitae hedge along south side of the garden as indicated in 6D.

**6I. Paths**

Replace missing north/south garden walkways.

**6C. FLOWER GARDENS – ANNUAL GARDEN**

---

**EVOLUTION/DESCRIPTION**

The Annual (fall) Garden is not well documented either verbally or photographically. Since it features annual beds, one of the few gardens at Allerton Park to do so, it changes from year to year. Unlike the other gardens, which reflect the design influence of Robert and John Allerton, this space, also known as the Foreman's Garden, was a place where the garden foreman could experiment seasonally with mass plantings.

The Annual Garden is a space roughly 125' by 40' which is bounded on the north and west by a double row of arborvitae, on the south by an arborvitae hedge backed by cedars and on the east by a high concrete wall. There is a central turf panel with planting beds around the perimeter. The statue of *Venus* was placed near the east wall circa 1970 but was removed in 1994 to slow its deterioration.

**CHARACTER DEFINING FEATURES**

- Narrow rectangular space enclosed on three sides by tall hedges and on the fourth by a high wall.
- The only entrance is a "hidden" gate on a secondary path.
- Central turf panel with perimeter beds planted with seasonal annuals, primarily hardy chrysanthemum varieties.

**ISSUES/RECOMMENDATIONS**

This garden is unique at Allerton Park. It has traditionally been a place to experiment with annual plantings, a function that could be further expanded to incorporate new varieties and planting combinations without detracting from the historic character of the gardens as a whole. The recommended treatment is to continue to use it as an annual display garden and a place for horticultural experimentation.

**6J. Espalier**

Restore espalier plantings on east wall.

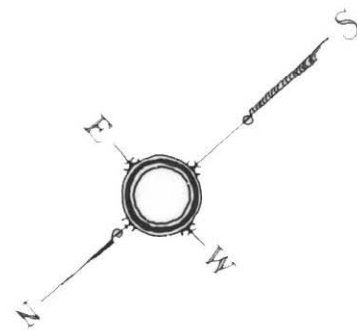
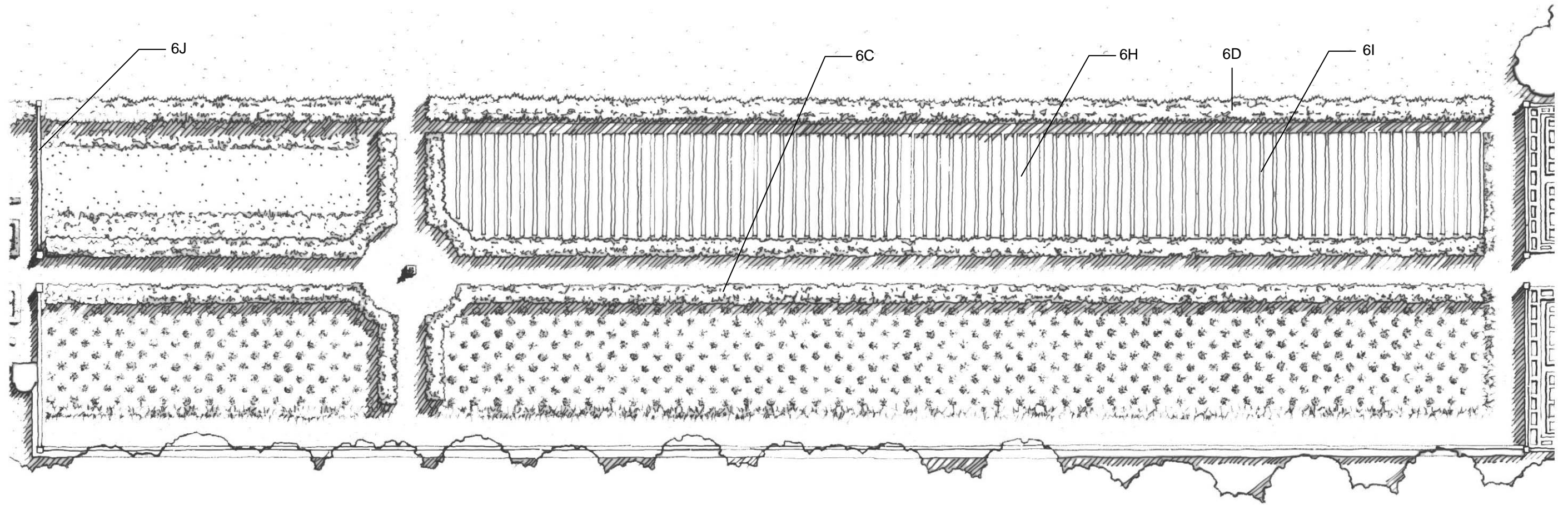

FLOWER GARDENS

7. CHINESE MAZE GARDEN

---

GARDEN EVOLUTION



**1912 (HGC-1)** This very early view looking northwest shows the basic features of the garden: high concrete walls, privet hedges in an elaborate maze-like pattern, and *Fu Dogs* at the center of each of the two maze squares. Hedges are very low and narrow with groomed pea stone in between.



**1915 (HGC-3)** By 1915 espaliered apples and pears had been added on the walls and herbaceous plantings around the perimeter. This view is looking northeast with the Peony Garden wall in the background.



**CULTURAL LANDSCAPE TREATMENT PLAN**  
**ROBERT ALLERTON PARK, MONTICELLO, ILLINOIS**

---



**1920 (HGC-9)** This view looking southeast shows the addition of statuary on top of the east wall and tall cylindrical pedestals on either side of the east entrance. Note urn on top of wall at corner of garden.



**1925 (HGC-12)** By 1925 the statues on either side of the east door had been changed to urns or vases. Later that year the Chinese *Fu Dogs* shown here were replaced by *Chinese Goldfish*, which are still in the garden.

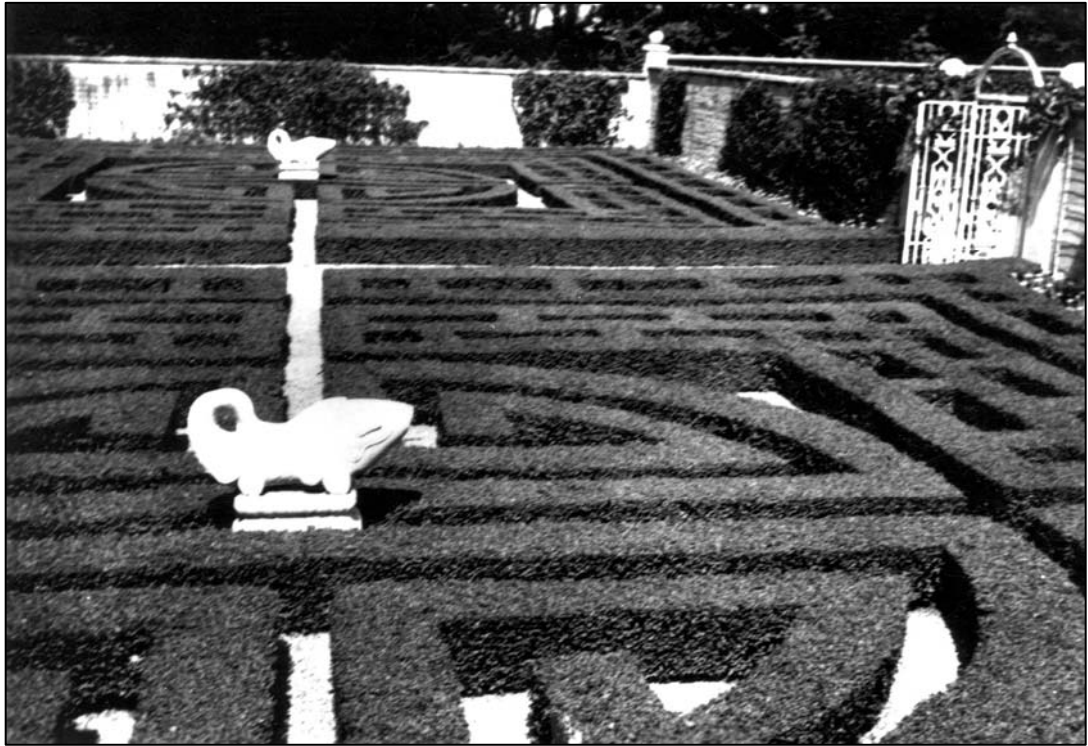

1935 (HGC-16) This 1935 view shows *the Chinese Goldfish* in the center of the beds and the Borie gates (relocated here from the Brick Wall Garden in 1930) at the east entrance (another set of gates was located at the west entrance). The cherub formerly above the east gate was moved to the Spring Garden House.

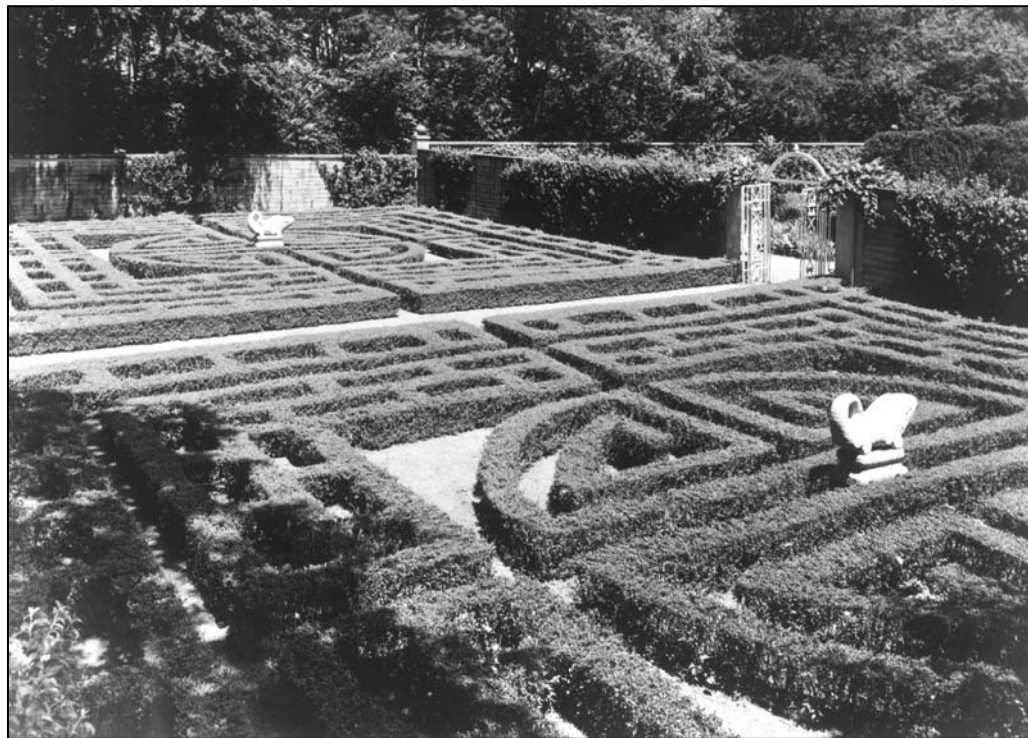

1944 (HGC-23) After 1930 there were few changes other than growth of vines on the walls.



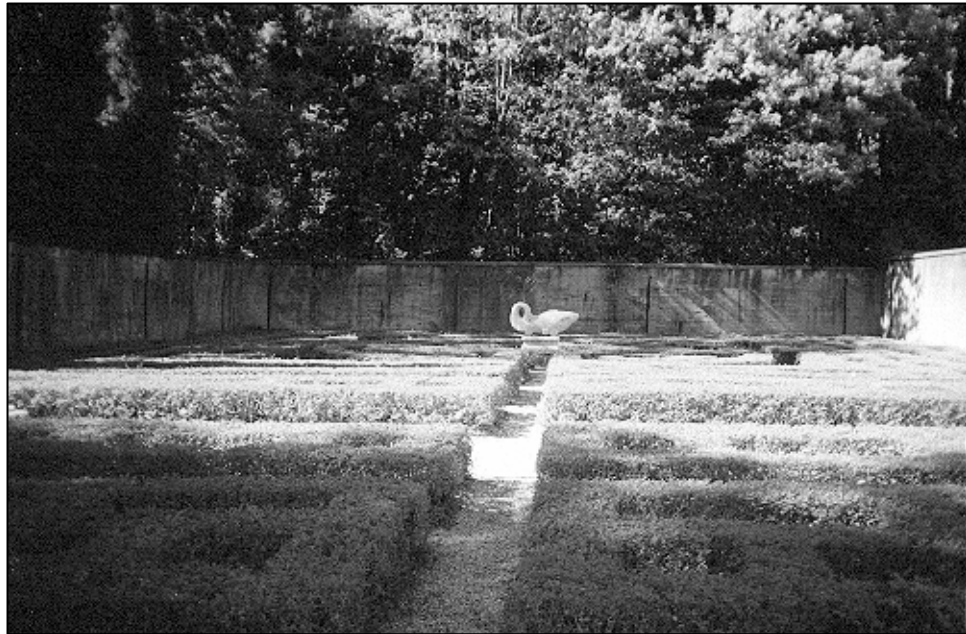

**2001** – This garden has changed relatively little since 1944 except that the mazes have become wider and the vines on the walls were more profuse.



**2001** – This narrow passageway east of the Chinese Maze Garden originally led to two stair pavilions. Remnants of one of these towers remains. The arborvitae that Allerton planted here have grown too large for the space and obscure the new ADA access path.

## **DESCRIPTION**

The Chinese Maze Garden, begun in 1912, was intended as the termination for the formal gardens until the construction of the Sunken Garden in 1915. The planting of the garden, with its geometrically patterned Amur privet, is similar to that of the two parterre gardens but unlike these gardens, the space is enclosed by a high concrete wall. The basic form and spatial organization of the garden have changed relatively little since it was established. The arched opening on the east side, which appears in early photographs, was replaced by the Borie gates in 1930. Sculptural elements have also evolved. In 1925 marble goldfish replaced the Fu Dogs in the center of the beds. Most of the other sculptures that Allerton placed in the garden during its early years were removed by 1935. The other main variable is the amount of vegetation on the walls, which appears heaviest during the 1930s and 40s.

In 1948 the maze hedge was constructed of approximately 4,129 plants of Amur privet spaced 9 inches apart. The hedges were pruned so that they remained 16 inches high and 16 inches wide. There was approximately 2,857 feet of single row hedge, plus 120 feet of double row hedge along the center aisle. The path was also 16 inches wide, covered with pea gravel. On the wall surrounding the maze garden were 15 pear and 3 apple trees espaliered against the walls, underplanted with sedum and August lilies. See 1948 report for additional detail.

In addition to the main garden space there is a narrow chamber running along the western edge of the garden. It is bordered on the east by the concrete wall of the garden and on the west by a tall wooden wall of horizontal boards, which also forms the eastern wall of the Avenue of the Chinese Musicians. The chamber originally provided access to two stair towers offering an aerial view of the Chinese Maze Garden. This chamber, a portion of which incorporates the ADA path, is now lined with overgrown arborvitae. In 1948 these were described as Pyramidal American Arborvitae spaced 10 feet apart and 18 inches from the wall, which were interplanted with a single row of Amur privet.

## **CHARACTER DEFINING FEATURES**

- Main garden space 126 feet long and 60 feet deep with secondary corridor to the west 9½ feet wide by 126 feet long.
- Rough finished concrete walls (ca 1910) enclosing main garden space, approximately 8 feet tall, with globe stones at each corner. Secondary corridor space created by tall wooden wall to the west of the garden.
- Two squares of low, clipped Amur River privet hedges, each in a geometric maze-like pattern.
- Wide central path of exposed aggregate concrete (which replaced pea stone in 2000) linking with other gardens.
- Statuary in center of mazes (*Fu Dogs* from 1912 to 1925, since 1925 *Chinese Goldfish*).
- Espaliered fruit trees on perimeter walls (heaviest in 1930s and 40s) underplanted with perennials.
- Borie gates (since 1930, recently restored).
- Stair towers in narrow corridor along western edge of garden (only remnants of one remain).

## **ISSUES/RECOMMENDATIONS**

This garden has a high level of historical integrity, with few changes occurring since it was established other than changes in statuary. Preservation of existing features is the primary recommended treatment except for replanting of perimeter walls.

### **7A. Privet Hedges**

Mazes have grown larger over time. Reduce height and width of maze hedges slightly to re-establish circa 1944 appearance (see HGC-23). Install weedmat and new gravel.

### **7B. Concrete Walls**

Clean and repair walls. Recent studies of the concrete garden walls by University of Illinois students have indicated that while there is evidence of deterioration problems such as spalling, disintegration, corrosion, cracking, discoloration and biological growth, the walls are still structurally sound and can feasibly be repaired and cleaned. See "Repair and Rehabilitation Strategies for the Robert Allerton Park Garden Wall," U of I, 1996 and "Historic Concrete Repair Investigation at Robert Allerton Park, Part I," by Amy Lamb Woods, U of I, 2000.

### **7C. Espalier Wall Plantings**

Walls were intended to be planted with espaliered fruit trees. Restore wall plantings and understory to mid-1940s appearance using 1948 plant list and image HGC-23 taken in 1944.

### **7D. Sculpture**

Conservator's report indicates that the marble *Chinese Goldfish* are deteriorating rapidly and recommends that they be replaced with newly carved copies, with originals preserved indoors. (See 1994 Forsythe survey and CSOS 2000 condition report for specific treatment recommendations.)

### **7E. Stair Towers**

Reconstruct stair towers as originally designed to serve as focal points in this narrow space. Only staff access should be permitted to top of wall.

### **7F. Arborvitae in Corridor**

The current arborvitae have grown out of scale and obstruct the pathway, which has assumed new importance now that the ADA route enters this passage. Remove overgrown arborvitae.

### **7M1. Trees Around Perimeter**

Overhanging trees provide a visual frame and shelterbelt but are also a potential hazard to concrete walls and shade out plant materials in the garden. Prune overhanging trees away from walls.

CULTURAL LANDSCAPE TREATMENT PLAN  
ROBERT ALLERTON PARK, MONTICELLO, ILLINOIS

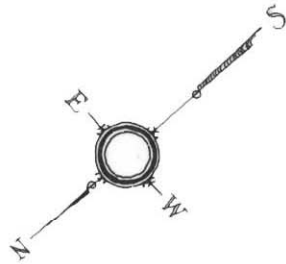
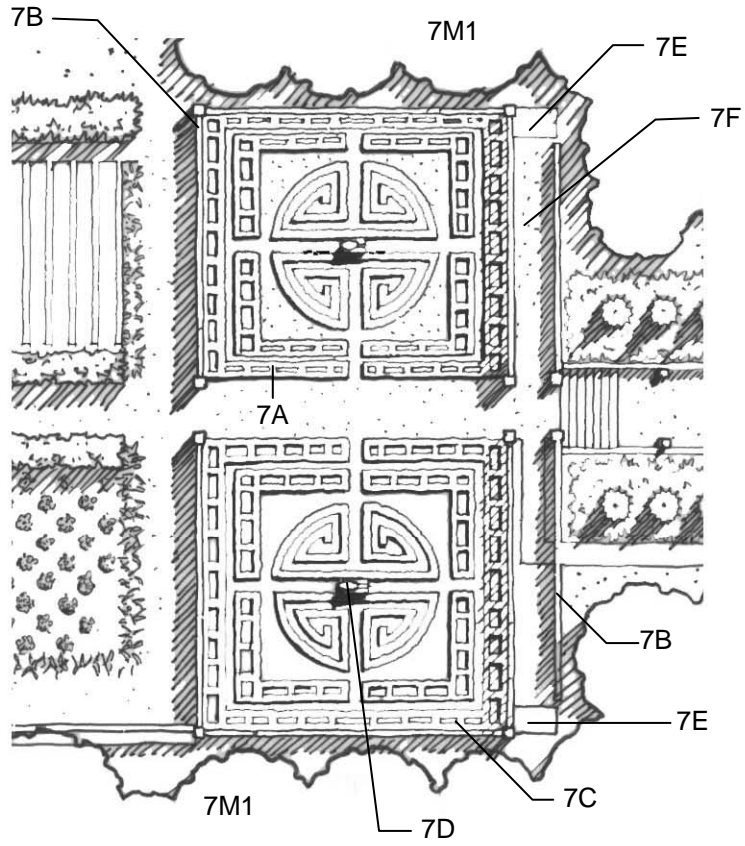

CHINESE MAZE GARDEN

8. AVENUE OF THE CHINESE MUSICIANS

---

GARDEN EVOLUTION



**1912 (HGET-1)** View east during construction circa 1912, with Chinese Maze Garden at rear. This garden was intended as an evergreen-lined passageway, punctuated by six pairs of columns surmounted by orbs. Wire trellises between the columns defined the edges of the space. This garden is lower in elevation than the Chinese Maze Garden, note steps at



**1912 (HGET-2)** This view looking west shows the garden soon after completion. A low curb has been added and there are some herbaceous plantings at the lower right. At times the evergreens were sheared to make the columns appear more dominant.





**1925 (HGET-6)** This view east towards Chinese Maze Garden shows the garden as the trees matured. By this time the garden was more enclosed and the pillars and wire trellises had been removed. The low curb is covered with ground cover.



**1935 (HGET-12)** This view looking west towards the Sunken Garden is similar to the one above. The *Chinese Musicians* were not moved here until after a fire destroyed the Lost Garden pavilion in 1972.



**2001** View looking east towards Chinese Maze Garden with newly planted hemlocks and vinca on either side of the path and newly cleaned and recarved musicians and bases.



**2001** – View looking west towards Sunken Garden.



### **DESCRIPTION**

This avenue forms a narrow, tree-lined connection between the Chinese Maze Garden on the east and the Sunken Garden on the west. Initially six pairs of columns lined the path and served as the major visual element, backed by first by Scotch pines and later by Canadian hemlocks. As the trees grew, the columns were removed circa 1925 giving the area a more naturalistic woodland character, which it retained until the *Chinese Musicians* were placed here in 1977. More recently, an ADA path was added north of the main path in 2000, as part of a larger project to make all the formal gardens accessible. The central portion of the garden was renovated in 2000, with new pea stone and plantings (hemlocks placed further back to allow room to grow and vinca in front) and cleaned sculptures and bases. Wire trellises have been added in the forest behind the space to serve as deer fencing.

### **CHARACTER DEFINING FEATURES**

- Wide gently sloping central path, a continuation of the path that connects the other formal gardens. This is the only section of the central path to remain pea stone since paving was added to accommodate ADA in 2000. Path lined with high concrete curb/low retaining wall. Steps leading down from the Chinese Maze Garden at the eastern end.
- Narrow tree-lined space. Evergreens lining the path create a sense of darkness and mystery in contrast to the more open adjacent gardens. Deciduous woodland to north and south.
- Six pairs of tall columns with wire trellises between (until circa 1920s).
- *Chinese Musicians* (since 1977) - Ten are limestone originals purchased by Allerton in England, two are copies commissioned by Allerton.

### **ISSUES/RECOMMENDATIONS**

A major rehabilitation of this space was undertaken in 2000, which included improvements to the path, replanting of adjacent vegetation, and cleaning and recarving of Chinese Musicians and bases. The decision was made at that time to preserve the post-1977 appearance of the space rather than return to its appearance during Allerton's tenure. All of the recommendations that follow are in the category of maintenance rather than capital projects.

#### **8M1. Hemlocks**

As newly planted hemlocks grow towards Chinese Musicians they should be pruned back to prevent damage to sculptures.

#### **8M2. Forested Areas at Outer Edges of Garden**

Remove deadwood and black locusts to create a more open woodland that is an appropriate backdrop to the garden. Keep vegetation pruned away from wooden wall to reduce moisture and to slow deterioration.

#### **8M3. Chinese Musicians**

Sculptures and bases have recently been cleaned and sealed. Provide ongoing assessment and maintenance program for sculptures.

CULTURAL LANDSCAPE TREATMENT PLAN  
ROBERT ALLERTON PARK, MONTICELLO, ILLINOIS

---

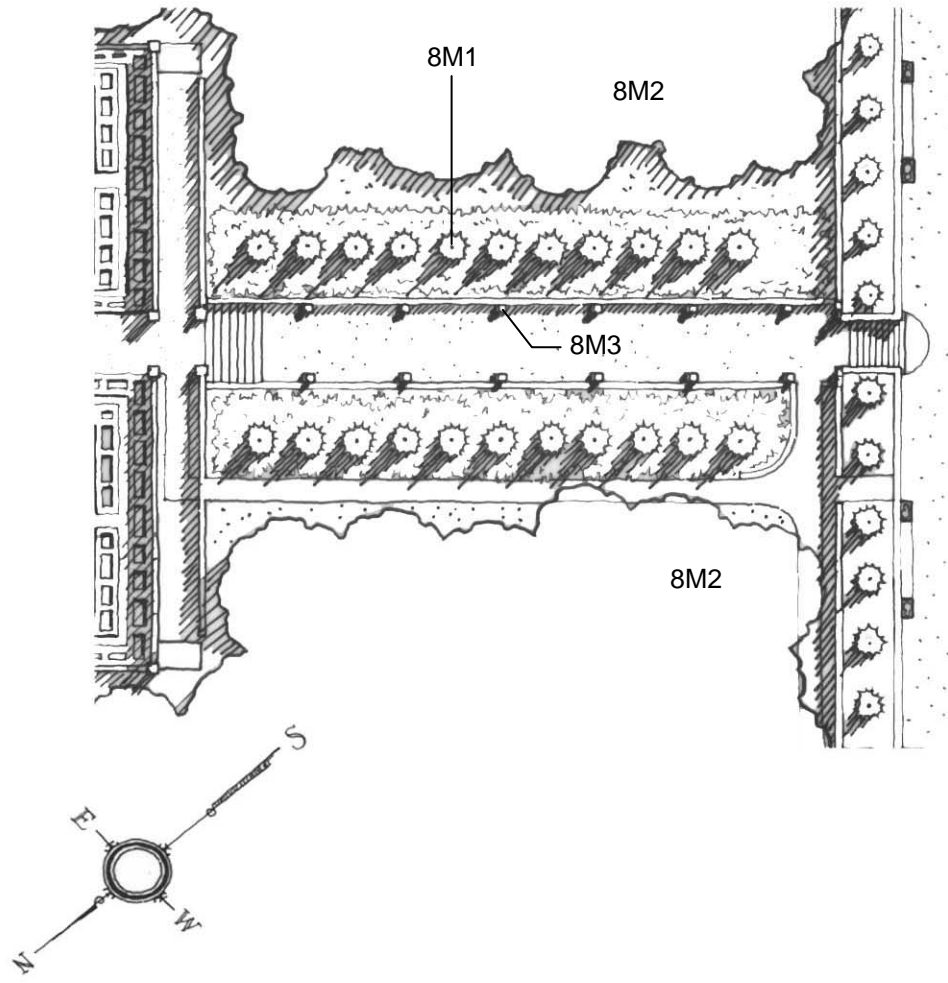

AVENUE OF THE CHINESE MUSICIANS

9. SUNKEN GARDEN

---

GARDEN EVOLUTION



**1917 (HGS-4)** This view shows the garden soon after construction with only the lower wall in place. *Fu Dogs* were placed around the interior of the garden floor. The site was previously used as a landfill and composting operation (which was relocated elsewhere).



**(HGS-3)** Early detail of concrete stair and wooden gazebo. A two-story wood and concrete gazebo replaced this in the 1920s.

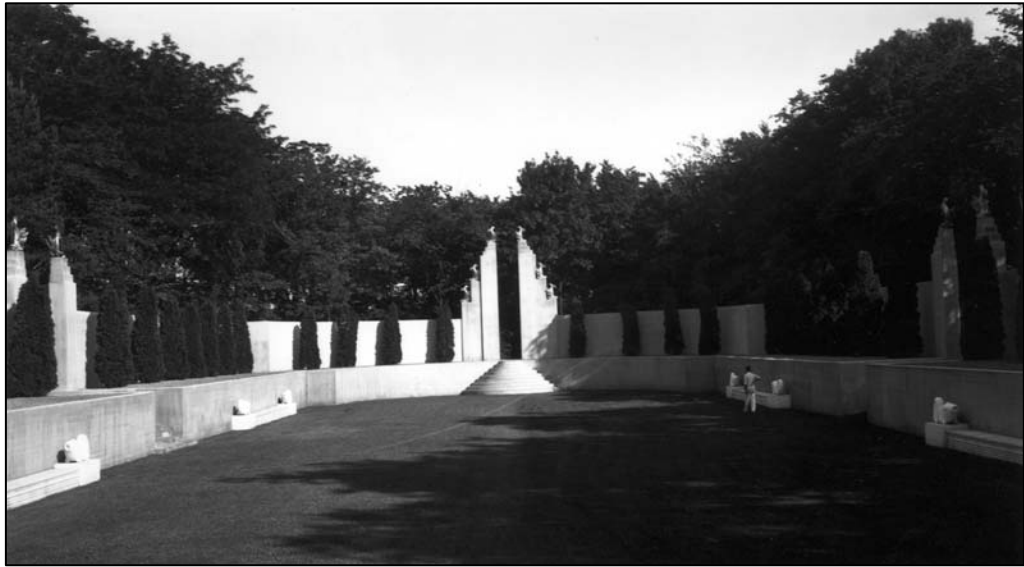

**1932 (HGS-29)** This view shows the upper walls, which were in place by 1925, new steps and entrances topped by Japanese *Guardian Fish*. Copies of the goldfish from the Chinese Maze Garden are at either end of the long marble benches.

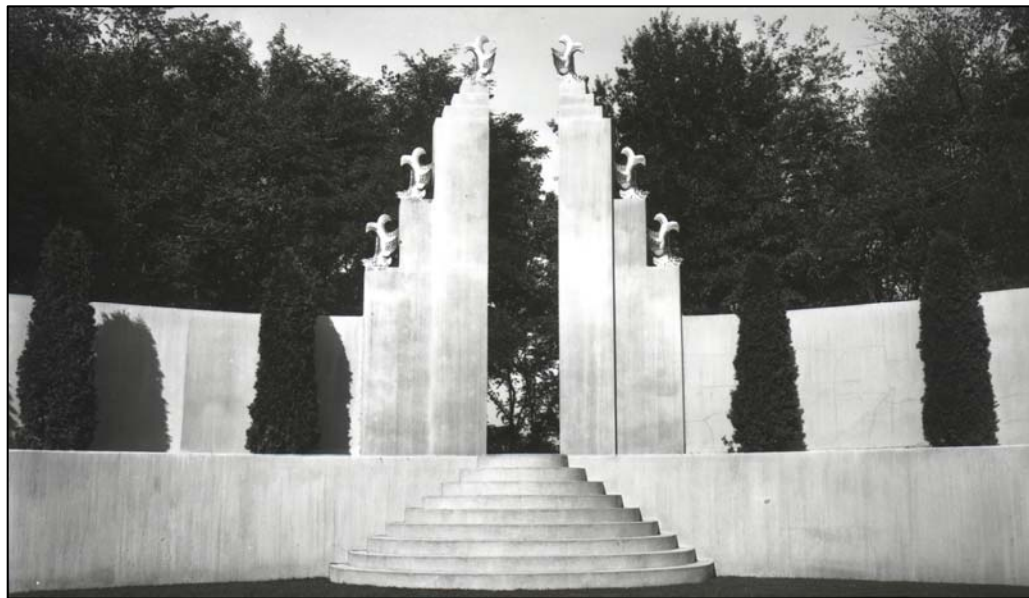

**1932 (HGS-25)** Detail of new entrance with pylons, semi-circular stair and gilded Japanese *Guardian Fish*. The fastigiata arborvitae winter killed on one side and shade-killed on the opposite side.

**CULTURAL LANDSCAPE TREATMENT PLAN  
ROBERT ALLERTON PARK, MONTICELLO, ILLINOIS**

---

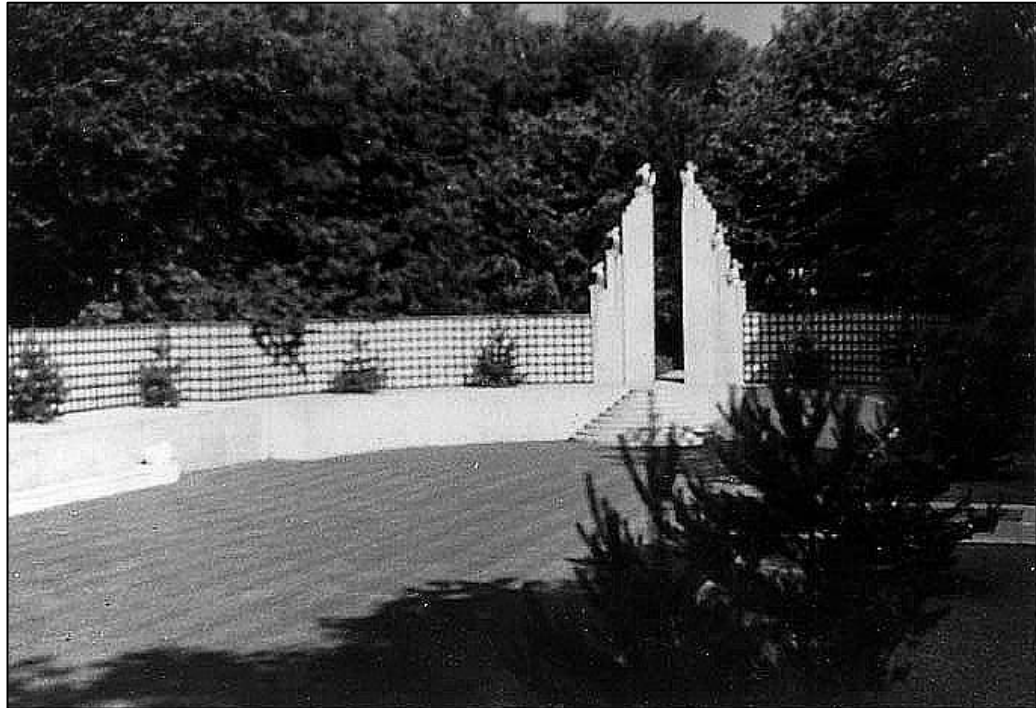

**1938 (HGS-40)** By 1938 the lattice had been added, the upright arborvitae was replaced by unsheared yellow pines, and the overall structure of the garden appeared much as it does today.

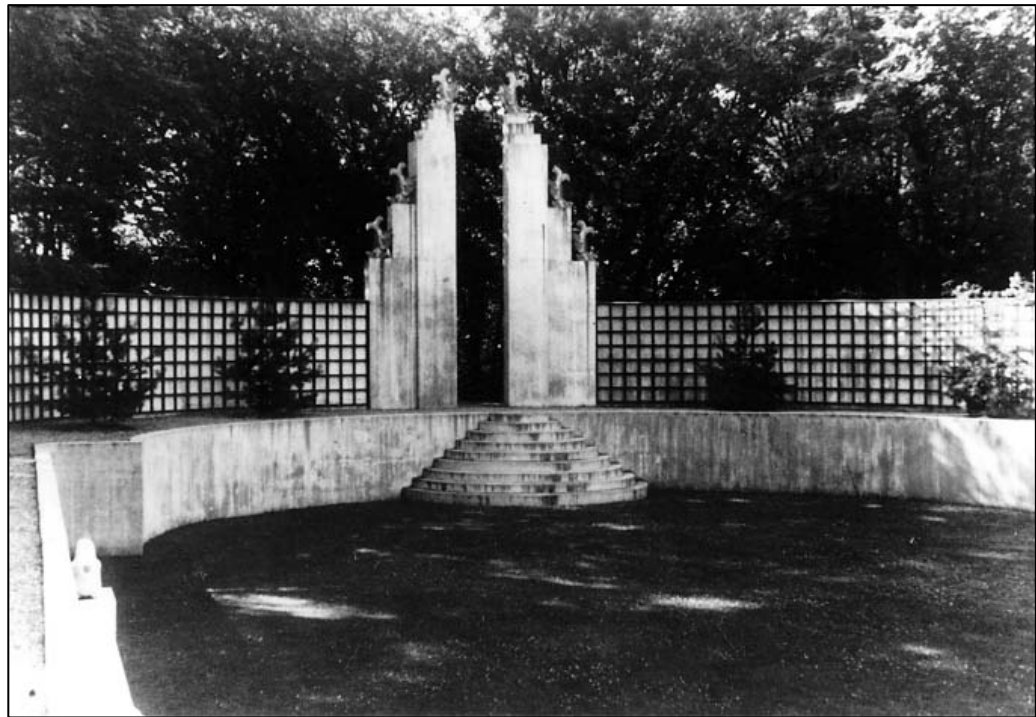

**1938 (HGS-41)** Detail of garden with decorative lattice.

**CULTURAL LANDSCAPE TREATMENT PLAN  
ROBERT ALLERTON PARK, MONTICELLO, ILLINOIS**

---



**2001** – Current view of Sunken Garden showing faded walls and evergreens that appear too large and dense for this space.



**2001** – Overhanging trees are a particular threat to the Japanese *Guardian Fish*.

## **DESCRIPTION**

The Sunken Garden was designed in 1915 as a finale to the formal gardens. Initially only the lower wall was constructed, with pines planted around the perimeter behind this wall. Two rustic gazebos were located at the ends with adjacent steps providing access down into the garden. There were also steps on the east side and a ramp on the west side. The gazebos went through several iterations before they were eliminated when a major redesign of the garden was undertaken in the late 1920s. At that time the upper walls were added, making the garden more enclosed, and much of the original sculpture was removed. In 1931 new entrance pillars were built and topped by gilded Japanese *Guardian Fish*, giving the garden an oriental feeling. Copies of the *Chinese Goldfish* replaced the *Fu Dogs*, which were moved to the Fu Dog Garden in 1932. The last major change was the addition of lattice on the upper walls in the late 1930s. There have been few changes since then.

This garden is unusual among the Allerton gardens in that it has no central path; the entire floor of the space is turf. The ADA path goes around the northern perimeter of the garden and enters on the ramp from the west. This is also an architectural garden with limited planting other than turf and the hemlocks, which are located inside the upper wall. There is no 1948 description for this garden, probably because the plantings were so simple that there did not seem to be a need for documentation.

## **CHARACTER DEFINING FEATURES**

- Long narrow rectangular space with semi-circular ends, sunken about six feet below grade. The space was established when the garden was created in 1915.
- Two sets of concrete walls enclose the garden. The lower walls (1915) are retaining walls. The upper freestanding walls (1920s) are located slightly outside the lower walls to create a planting ledge. Both sets of walls appear white in 1930s photographs but have since become stained, giving the garden a more rustic appearance than was intended.
- Concrete pylons approximately 24 feet tall at the northern and southern ends of the garden, with smaller, simpler pylons at the eastern and western entrances.
- Semi-circular stairs extending into the garden at the north and south entrances with recessed stairs at the east entrance and a recessed ramp at the west entrance.
- Square wooden lattice, stained green, on upper walls (since 1938).
- Japanese *Guardian Fish* (Shachi) (since 1931). These are gilded bronze fish, copies of Japanese originals. There are three on each of the north and south pillars, one on each of the east and west pillars.
- Eight stone copies of *Chinese Goldfish* at ends of long benches designed in early 1930s by John Gregg Allerton.
- Forty evenly spaced hemlocks around perimeter of garden (since 1980s). Prior to that arborvitae, then pines were used.
- Vista towards *Centaur* to the west and Chinese Maze Garden to the east.



## **ISSUES/RECOMMENDATIONS**

This garden assumed its present form by the late 1930s and has changed relatively little since then. The structure of the garden has a high level of integrity, although changes in finishes have altered the overall effect. Preservation of existing features is the recommended treatment, with some restoration of finishes on the walls, lattice and *Guardian Fish*. Since the garden has excellent acoustics, some adjustments may be desirable to adapt the space for informal performances and weddings.

### **9A. Concrete Walls and Entrance Pylons**

Walls in the Sunken Garden are comprised of a different concrete mix than the other garden walls and are thicker at the pylons. The lower retaining walls have a different capping detail than the rest of the walls in the formal gardens. There is some settling and cracking which may be evidence of structural instability. For further information see "Historic Concrete Repair Investigation at Robert Allerton Park, Part I," by Amy Lamb Woods, U of I, 2000, as well as Proposal/Contract by Western Waterproofing Company Inc., November 2, 1999. Walls should be repaired and returned to their original white surface appearance.

### **9B. Lattice**

Lattice is deteriorated in some places and should be removed to address wall coating issues. Repair or replace lattice on upper wall. Consider hinging or panelizing for easy removal during wall treatment. Use paint analysis to determine original green color of lattice (it appears much darker in 1930s photos than it does today). This work should be done after wall issues have been resolved.

### **9C. Japanese Guardian Fish**

Fish are faded and have not been inspected recently. Repair/regild, check attachment to pylons. Follow conservator's recommendations regarding details of treatment, including environmental issues such as pruning trees away from sculptures. See COSOS Inc. report, May 2000 for treatment recommendations and cost estimates.

### **9D. Chinese Goldfish and Adjacent Benches**

Goldfish in Sunken Garden are copies, not originals. Follow conservator's report regarding treatment. Establish regular cleaning and maintenance program. See COSOS Inc. report, May 2000 for treatment recommendations and cost estimates.

### **9E. Hemlocks**

Hemlocks are a replacement planting that is too large and dense for the intended design. Replace hemlocks with more compact and open upright species such as capitata yews or smaller hemlocks regularly pruned to maintain compact size.

### **9F. Turf**

Turf is compacted and poorly drained. Reconstruct lawn, amend soil, and install new drainage and irrigation systems to ensure preservation and easy maintenance of turf.

### **9G. View towards Centaur**

View towards *Centaur* is partially obscured by vegetation. Remove spruces west of Sunken Garden. Clear wide vista towards the *Centaur*.

**9H. South End**

There are several tripping hazards at the south end of the garden. Install concrete pad at top step similar to north end. Install railing at south curb.

**9I. Electrical Hook-up**

Provide electrical feed for special event use. Limited unobtrusive low-level night lighting, especially between garden and adjacent parking area, should also be considered for special event use.

**9M1. Surrounding Vegetation**

Overhanging vegetation shades garden, making growth of turf and hemlocks difficult. Prune back overhanging vegetation, particularly black locusts, black walnut and trees that are threatening sculptures and walls.

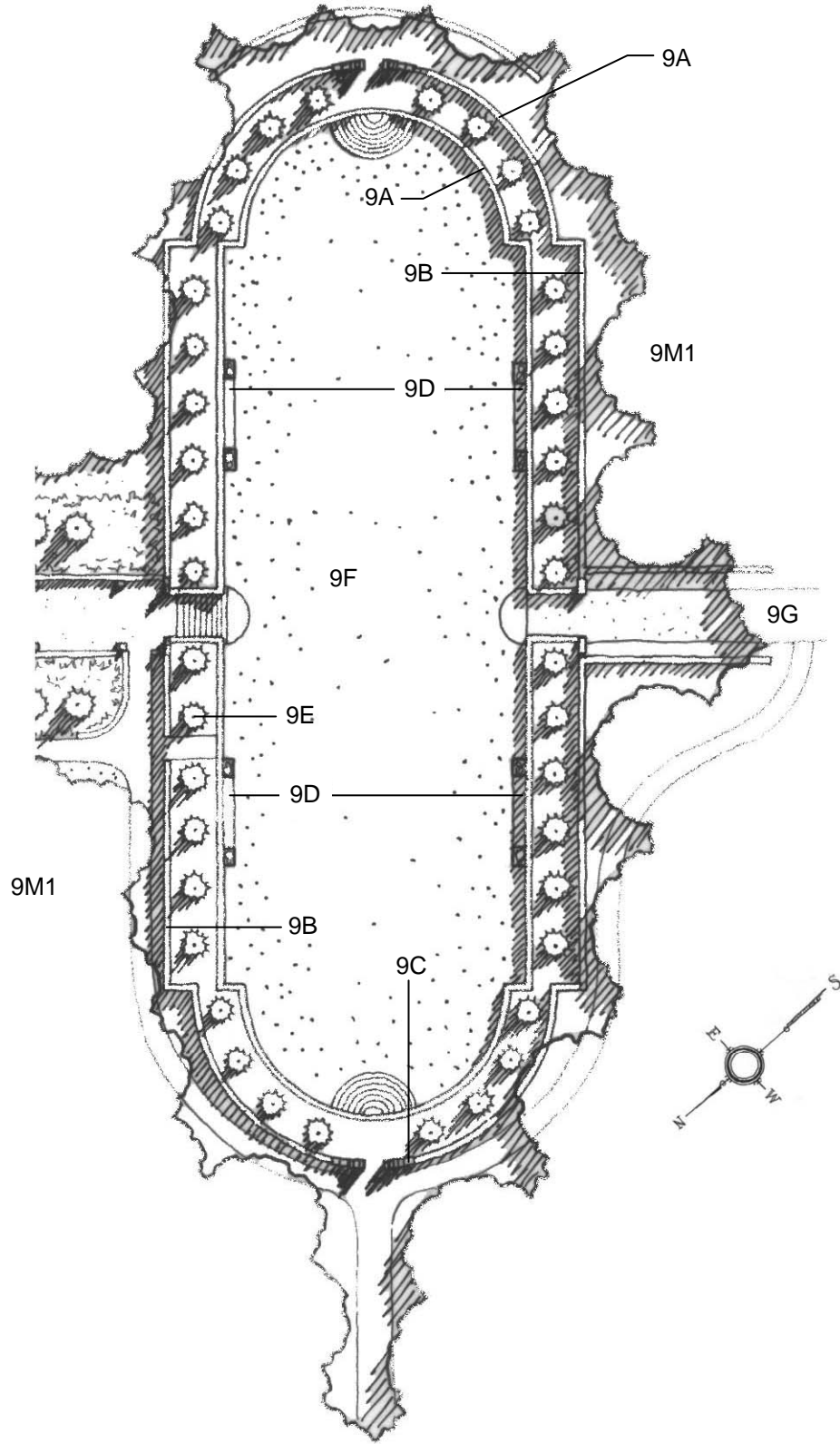

SUNKEN GARDEN

10. CENTAUR

---

GARDEN EVOLUTION



1935 (HGCN-8) Early view of *Centaur* in its setting, with pedestal and benches, but no hemlocks behind the benches.



1935 (HGCN-9) Similar view showing the openness of the space at this time.



**1935-40 (HGCN-17)** This view looking down the steps towards the south pylons illustrates a much stronger visual connection than exists today.

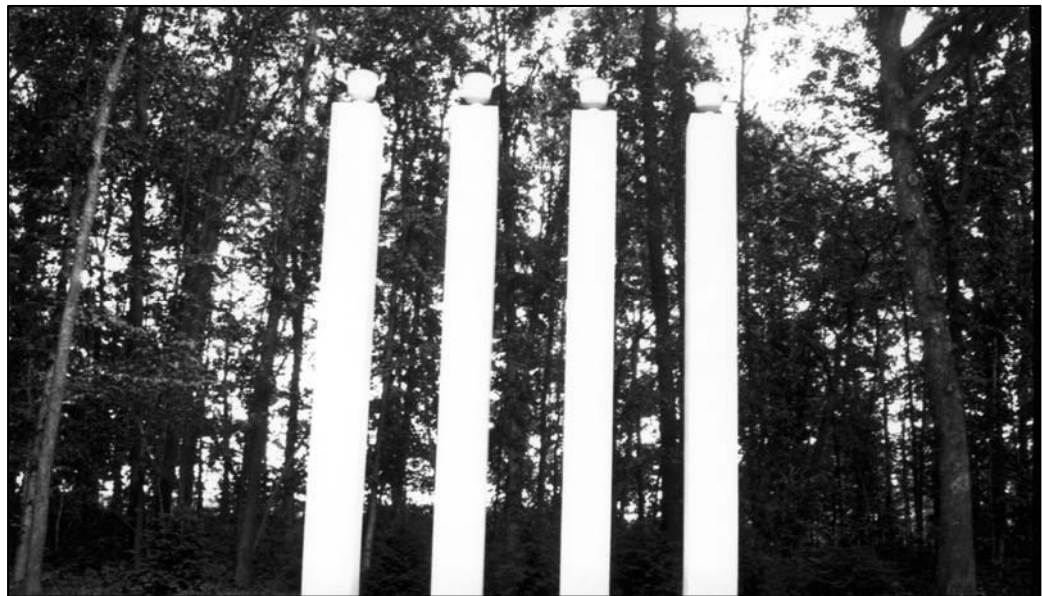

**1940 (HGCN-18)** Detail view of north pylons with Swedish urns on top.





**2001** – The *Centaur*, with its gold flecked bronze finish, was meant to be seen in the sunlight rather than the shade. Compare this view with HGCN-9, taken in 1935.



**2001** – The connection of the *Centaur* with its outlying spaces has been largely obscured by the growth of vegetation. This view is similar to HGCN-17 from the late 1930s except that the pylons are no longer visible.

## **DESCRIPTION**

This space, designed by John Gregg Allerton, is primarily a setting for Emile-Antoine Bourdelle's monumental bronze sculpture, *The Death of the Last Centaur*, which Robert Allerton purchased in 1929. It is linked to the formal gardens by a path but is far enough removed to feel very separate, with the sense of remoteness enhanced by the woodland setting.

The setting for the *Centaur* actually consists of three distinct spaces. The sculpture was designed to be approached from the south. In the forest near the Sangamon River, Allerton created a rectangular clearing where viewers left the surrounding natural woodland and entered a mysterious trellis-enclosed space with four tall pylons surmounted by Swedish cauldrons. Visible in a raised clearing to the north, accessible by a series of steps, is the *Centaur*. The central space where the *Centaur* is located is at the intersection of the forest path and the path from the formal gardens. It consists of a small glade in the forest surrounded by four benches with Canadian hemlocks beyond. The cathedral-like corridor continues north beyond the *Centaur* to another space where four additional pylons are located. The path continues to the park road just beyond. See 1948 description for additional information regarding woodland plantings.

## **CHARACTER DEFINING FEATURES**

- *The Death of the Last Centaur* by Emile-Antoine Bourdelle (gold embedded in bronze, cast 1914, installed 1929) is the primary element around which this space was designed.
- Two tiered octagonal concrete base designed by John Gregg Allerton (1929). Base was later modified by a new layer of concrete, which raised the lower level by about two inches.
- Four segmented concrete benches that echo the octagonal form of the base (1929).
- Evergreens have been planted behind benches periodically, most recently in the 1990s with Canadian hemlock. The earliest views of this garden do not show any plantings here. Arborvitae were used at one time.
- Compacted dirt path from formal gardens forming east /west axis of central space.
- North/south path connecting Sangamon River and park road.
- Set of 60 concrete steps leading from river up to *Centaur* (steps in place by 1927).
- Planting of vinca along steps.
- North space with four 22-foot tall concrete pylons surmounted by four Swedish cauldrons, connected to *Centaur* space by wide opening in the forest.
- South space at much lower elevation than *Centaur* was intended as the primary arrival point. It contains four tall concrete pylons surmounted by four Swedish cauldrons (cauldrons currently removed). This space is much better defined than the northern entrance as it is enclosed by tall wire trellising which extends part way along the path towards the steps.



## **ISSUES/RECOMMENDATIONS**

The *Centaur* area is one of the most powerful design statements at Allerton Park. It is also a remarkably fragile design, literally carved out of the wilderness. Recommendations focus on preservation of existing features and restoration of outlying areas to re-establish the full intent of the design.

### **10A. Pylons**

The pylons in the north and south spaces are spalling badly with evidence of recent losses. This is an emergency situation that needs immediate attention. If pylons cannot be stabilized, they should be removed and replaced. Clean pylons to re-establish their earlier appearance as much as possible.

### **10B. Swedish Cauldrons**

The Swedish cauldrons are deteriorated and mounted on pylons, which are in poor condition, presenting a potential hazard. The cauldrons from the southern pylons were removed for safekeeping in 1977. The four from the northern space should be removed until structural repairs to the pylons can be completed. All eight cauldrons should be evaluated by a conservator and treated in accordance with conservator recommendations.

### **10C. Death of the Last Centaur**

Preservation of the *Centaur* is a high priority for this space. Sculpture needs to be waxed periodically so that bronze color is retained.

### **10D. Erosion**

The area around the base of the sculpture is compacted earth that is eroding onto the adjacent stairs. Regrade around sculpture base to eliminate erosion. Add underdrain if required. Plant area surrounding sculpture with a combination of fescue and path sedge.

### **10E. Forest Corridor**

The corridor linking the three spaces associated with the *Centaur* is overgrown, destroying the visual connection between the *Centaur* and the pylons. Prune to create high wide corridor that emphasizes that these are designed spaces in a natural woodland. Selectively prune around *Centaur* to create a clearing in the woods that allows *Centaur* to be seen in sunlight to the extent possible. Prune deadwood away from pylons.

### **10F. Ornamental Plantings**

Ornamental plantings associated with the trellises at southern space have largely disappeared. Once corridor has been opened, re-establish Japanese honeysuckle, wisteria and grape vines on trellising. Maintain vinca along steps as an ornamental planting. Prune/weed periodically.

### **10G. Hemlocks**

Hemlocks near Centaur are intended as a relatively low backdrop to the benches but have consistently grown out of scale. Since maintenance of these trees at a size consistent with their original intent is difficult, when the current trees grow out of scale they should be replaced with low woodland understory.

**10H. North Space**

Pedestrian entrance from parking area to north pylons is awkward and too narrow. Redesign path to meet the space perpendicular to and east of the pylons rather than coming in behind pylons, which is awkward.

**10I. Sculpture Base**

An extra layer of concrete has been added at the sculpture base, altering the intended presentation of the Centaur. Eliminate extra layer of concrete, re-establish original height and appearance of base.

**10M1. Invasive Vegetation**

Invasive plant material, most notably poison ivy, is encroaching on paths and main spaces. Remove invasive vegetation.

CULTURAL LANDSCAPE TREATMENT PLAN  
ROBERT ALLERTON PARK, MONTICELLO, ILLINOIS

---

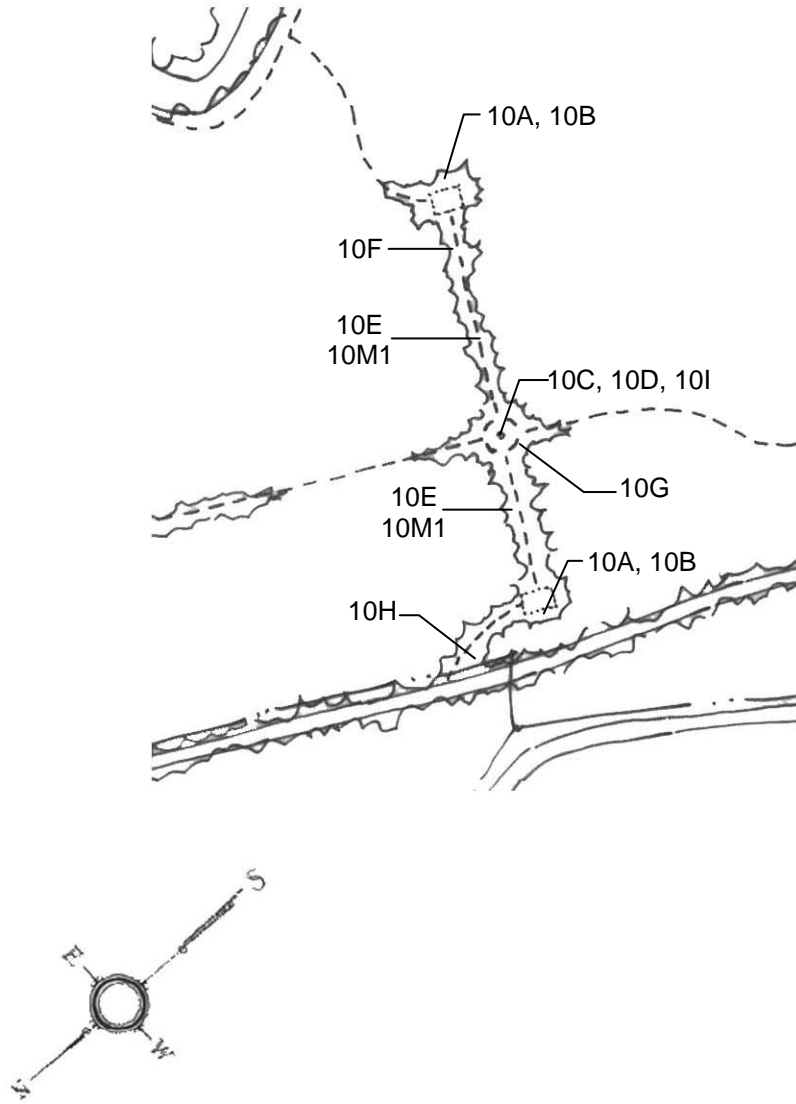

SCALE: 1" = 500'

CENTAUR GARDEN

11. SUN SINGER

---

GARDEN EVOLUTION



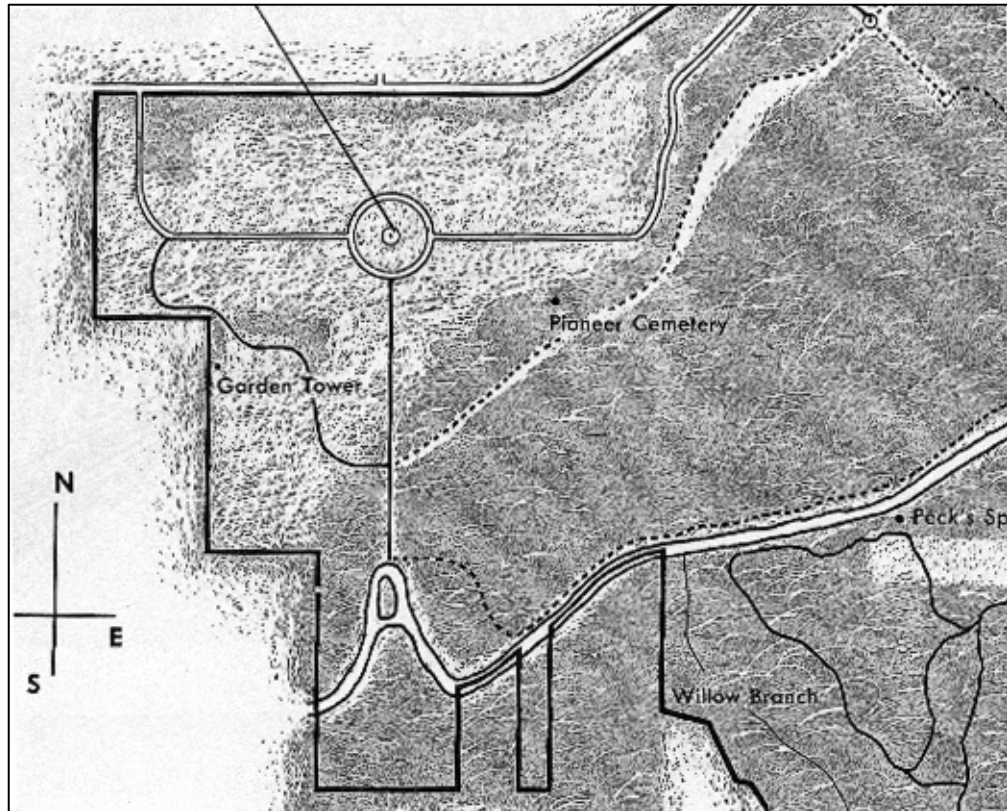

Detail of late 1940s plan showing extent of cleared area around the *Sun Singer* (located in circle at upper left). This plan also shows the location of the Pioneer Cemetery and the Garden Tower (which was removed by the University).

#### DESCRIPTION

This space was created solely as a setting for the *Sun Singer*, which arrived from Sweden in 1931 considerably larger than expected. It is one mile from the house and is separate from the other gardens, which are linked by a connecting path. Allerton's intent was to set the sculpture in a remote location where it seemed "larger than life." The Swedish sculptor Carl Milles later visited and heartily approved of the simple dramatic setting designed by John Gregg Allerton. The *Sun Singer* is reached by a road leading to the sculpture, and continuing in a large circle around it. As the road approaches from the east, a frontal view of the *Sun Singer* is visible in the distance. Initially there was unclipped meadow beyond so the sculpture was seen against the sky. Today it appears against the forest until one is quite close. The large circular base echoes the form of the surrounding roadway.

#### CHARACTER DEFINING FEATURES

- Bronze *Sun Singer* by Carl Milles on limestone pedestal (cast 1929, sited here 1932) set on two-tiered base exposed aggregate concrete surrounded by low plantings (1932).
- Low hedge around base, initially coralberry (1932), later replaced by Japanese yew.
- Large turf circle of Kentucky bluegrass.

- Asphalt road approaching Sun Singer from the east and proceeding in large circle around sculpture. Remnant paths to south and west reflect the compass points.

**ISSUES/RECOMMENDATIONS**

The Sun Singer is the dominant feature in this simple space, which retains a high level of integrity to its period of construction in the early 1930s. Treatment recommendations focus on preserving extant features and restoring the intended openness of the site.

Paving in this area is deteriorated and needs to be resurfaced but this project is considered to be a part of Allerton Park's overall program of roadway improvements and not a project specific to this space. Although vandalism has been a problem in the past, curbing is not recommended as it would detract from the setting and would not deter serious vandals from driving on the lawn. Hours of vehicular access should be clearly posted and the area should remain gated during night time hours. During peak visitation times, it may be desirable to have a volunteer in the area.

**11A. Sun Singer and Limestone Pedestal**

The *Sun Singer*, one of the most valuable and distinctive sculptures at Allerton Park, requires ongoing care which should be accomplished in accordance with conservator recommendations (see COSOS, Inc. report, May 2000), including replacement of chipped limestone pedestal and removal of aluminum cap.

**11B. Plantings Around Base**

The current Japanese yew hedge is too tall, too wide, and is crowding against the base. Replant with coralberry (*Symphoricarpos orbiculatus*, *Symphoricarpos X chenaultii* 'Hancock') or similar shrub.

**11C. Woodland Behind Statue**

The *Sun Singer* was intended to be seen against the horizon. Clear forest behind sculpture to restore the circa 1946 tree line to the extent feasible.

**11M1. Sculpture Base**

Sculpture base, especially joint caulking, has been damaged over the years. Repair joint caulking and apply sealant to concrete surface to prevent further deterioration.

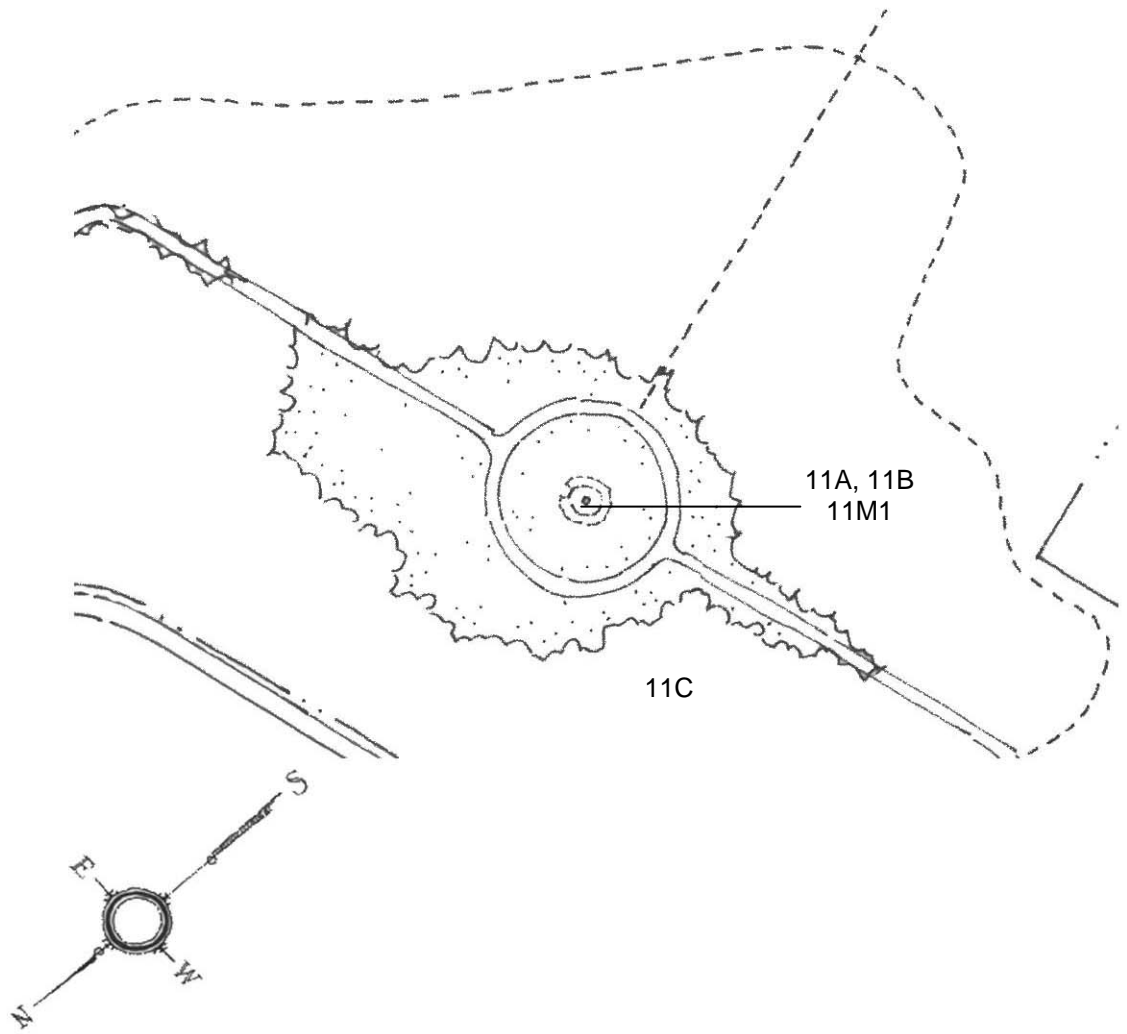

SCALE: 1" = 400'

SUN SINGER GARDEN



12. VINE WALK

---

GARDEN EVOLUTION



1918 (HGFD-1) Early view of the Vine Walk showing the trellis structure and bulb plantings. Note the openness of the surrounding pasture land.



1925 (HGFD-2) Slightly later view with the House of the Golden Buddhas in the

**CULTURAL LANDSCAPE TREATMENT PLAN  
ROBERT ALLERTON PARK, MONTICELLO, ILLINOIS**

---



**1938 (HGFD-3)** View east along the Vine Walk from the house entrance drive. The pillars still exist but this section of the Vine Walk has since been removed.

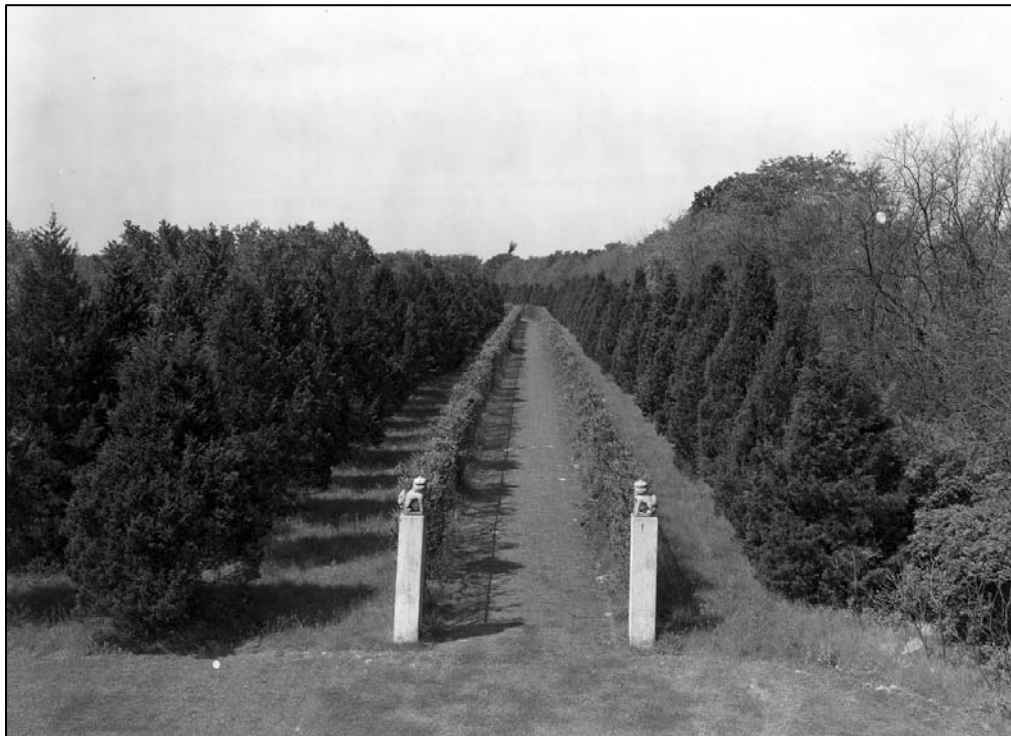

**1944 (HGFF-1)** View west along the Vine Walk from atop the House of the Golden Buddhas showing the central walkway and the adjacent Eastern red cedar plantings.



1925 (HGFF-03) Early view of the House of the Golden Buddhas with Vine Walk in foreground.



2000 – Current view of House of the Golden Buddhas covered with wisteria. Top is now white and replacement doors (which partially obscure view of sculptures) have been added for security.



**2001** – The east end of the Vine Walk, seen here from House of the Golden Buddhas, is from the same point as HGFF-1 taken in 1944. This section of the Vine Walk retains its basic form but the intended plantings have largely been replaced by invasive vines.



**2001** – The west section the Vine Walk is missing and forest has grown up in the surrounding areas that were initially open fields. Remnant cedars line the narrow clearing where the Vine Walk was located.

## **DESCRIPTION**

The Vine Walk, laid out circa 1915, is located on the northeast side of the property leading to the House of the Golden Buddhas (and later the Fu Dog Garden). It consists of a long narrow grassy walkway enclosed on both sides by an 8' high wire trellis covered with wisteria vines. The western segment was removed, at Robert Allerton's request, in 1947 after the visitor parking lot drive bisected the area. There is no 1948 plant inventory for this garden.

## **CHARACTER DEFINING FEATURES**

- Long narrow linear space, originally extending from main house entrance drive to House of the Golden Buddhas. Only the eastern half of the Vine Walk remains.
- Wire trellises supported by concrete posts originally planted with Chinese wisteria and underplanted with bulbs, originally extending from main house drive to House of the Golden Buddhas (1918).
- Pair of segmented brick columns at west end with concrete base and capstone topped by garlanded urns. Until 1947 the columns formed the western end of the Vine Walk.
- Evenly spaced allee of cedars behind Vine Walk, now becoming overmature.
- The House of the Golden Buddhas was built as a concrete gazebo in 1915. The cast iron upper structure was added in 1924. There have been various sculptures in the structure. Since 1934 these have included two painted teak *Siamese Buddhas* and one *Hari-Hara*. Structure was panted with wisteria and honeysuckle.

## **ISSUES/RECOMMENDATIONS**

This space underwent a major change in 1947 when it was bisected by the entrance road to the parking lot. At that time the western half of the Vine Walk was removed. The remnant eastern section is awkward and incomplete. Reconstruction of the western section of the Vine Walk is recommended to restore the design intent as much as possible.

### **12A. House of Golden Buddhas**

This structure is in need of restoration/rehabilitation, a project that could be addressed separately from the garden work. Issues include: repair of ironwork; upgrading of stairs and rails; taller doors so sculptures can be viewed better while closed. Prepare Historic Structure Report to develop specific preservation treatment recommendations.

### **12B. Siamese Buddhas and Hari-Hara**

These sculptures, located in the House of the Golden Buddhas, were poorly conserved in the past. Provide professional conservation treatment and adequate security measures to ensure long-term preservation.

### **12C. Adjacent Forest**

The forest adjacent to the Vine Walk has become overgrown and narrow, shading out the intended plantings of the walkway. Prune back forest to re-establish garden space at its original width and to provide sufficient sunlight for vines and cedars.



**12D. Cedars**

The cedars lining the Vine Walk are now nearing maturity, with many plants missing, and are shading the Vine Walk. Once forest has been pruned back to allow adequate space and light, remove remaining cedars and replant a double row on the south side and a single row on north side with the same or a more compact variety.

**12E. Vine Walk Structure**

The western section of the Vine Walk was removed in 1947 and not replaced. The eastern section is deteriorated and broken in places. Restore deteriorated trellising in eastern section. Replace missing western section of trellising and repair existing brick columns.

**12F. Vine Walk Plantings**

Vines have been shaded out by adjacent trees and wisteria has been crowded out by invasive vines. Ground is compacted with poor quality turf and inadequate drainage. Once adjacent forest has been cut back (see above) restore trellis plantings with new wisteria and narcissus and new turf capable of handling heavy pedestrian traffic.

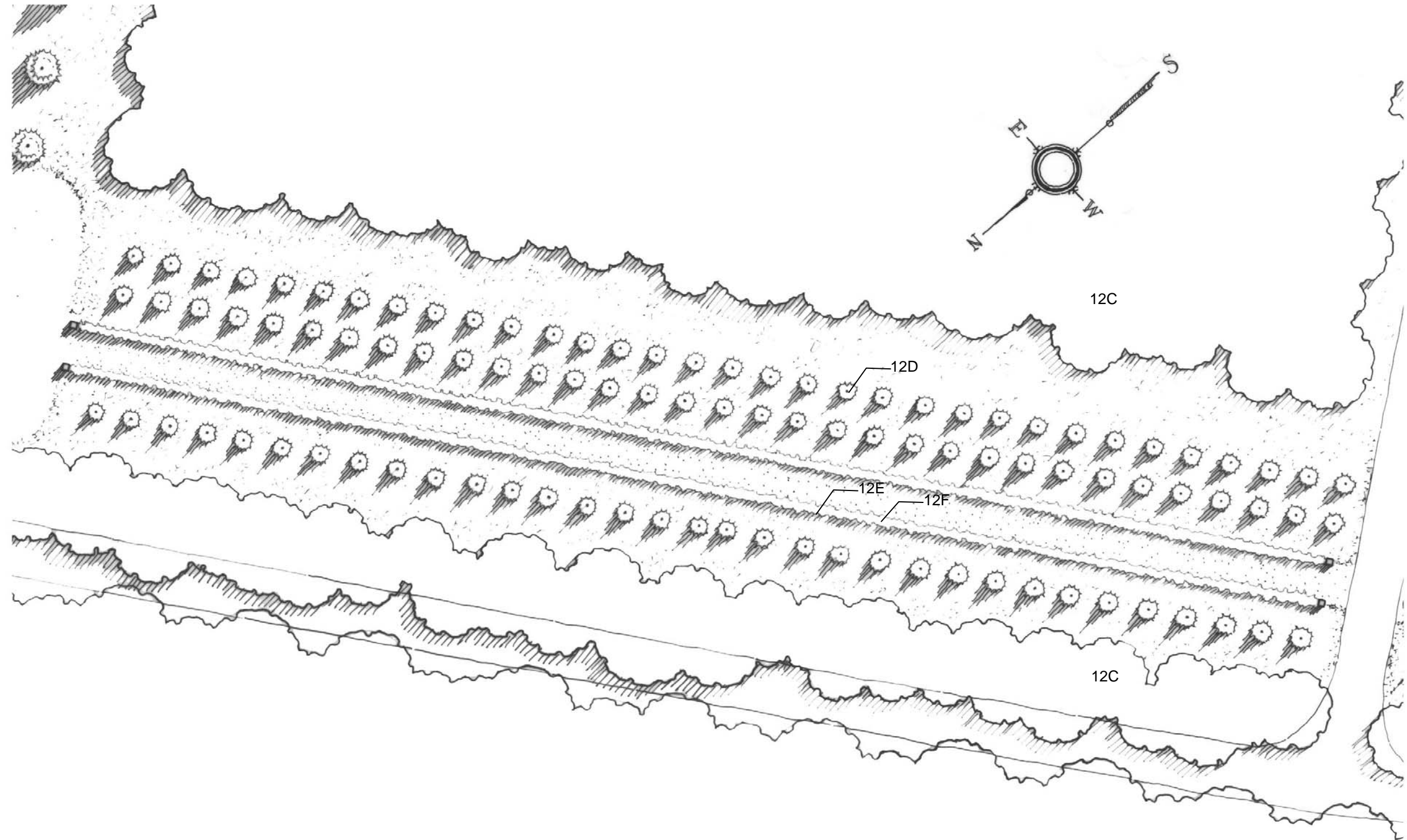

WINE WALK GARDEN NORTH



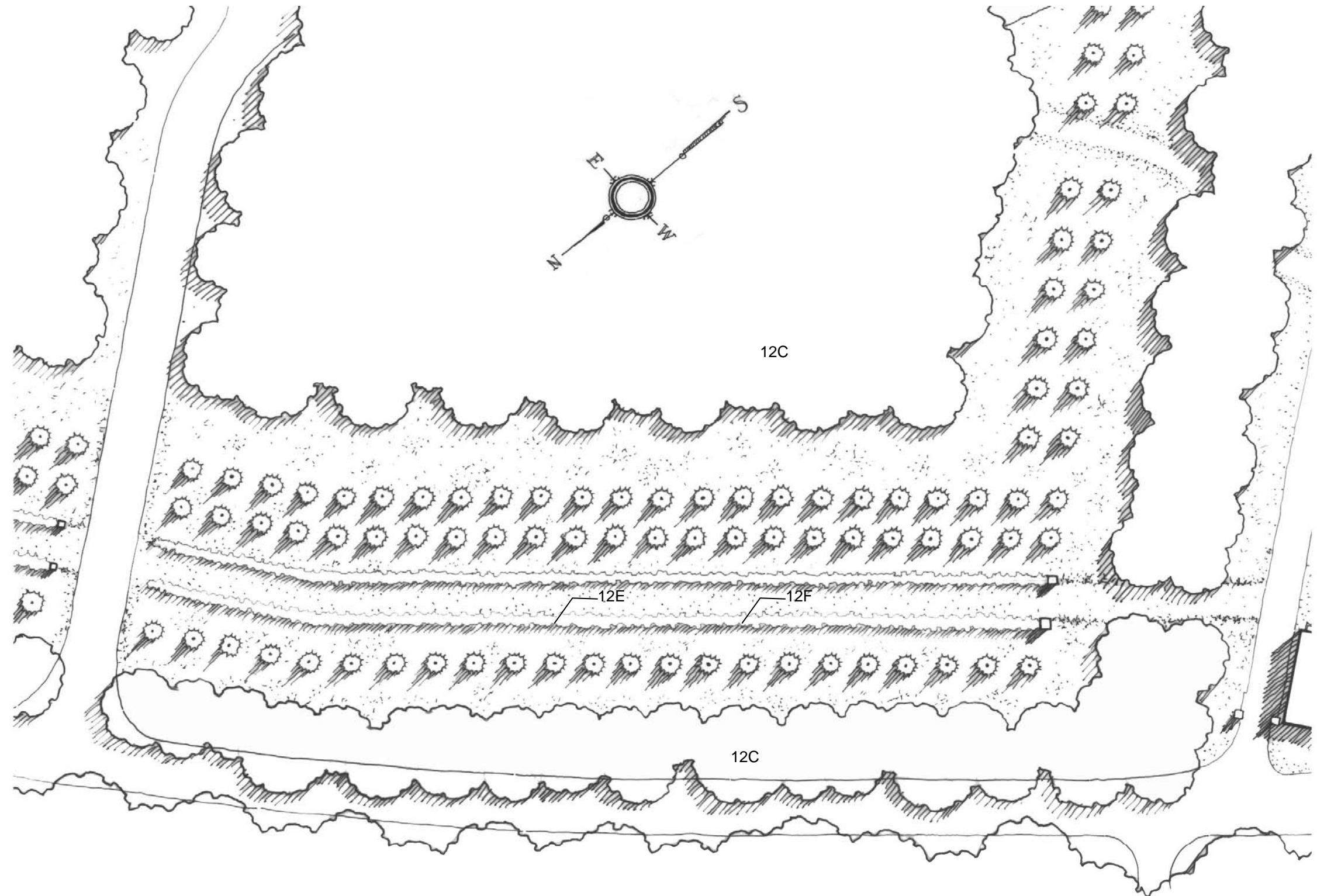

VINE WALK GARDEN SOUTH

13. FU DOG GARDEN

---

GARDEN EVOLUTION



1932 (HGFG-1) This view shows the Fu Dog Garden during construction. Note low triangular hedges in front of pedestals, openness of landscape beyond, and small size of fir trees behind *Fu Dogs*.



1937 (HGFG-7) This view, also taken from the House of the Golden Buddhas, shows the garden with rectangular curbing in place and maturing trees.



1944 (HGFG-8) This view shows little change since 1937 other than the growth of trees. Note that central turf panel is mowed, while grass is longer behind the curbing.

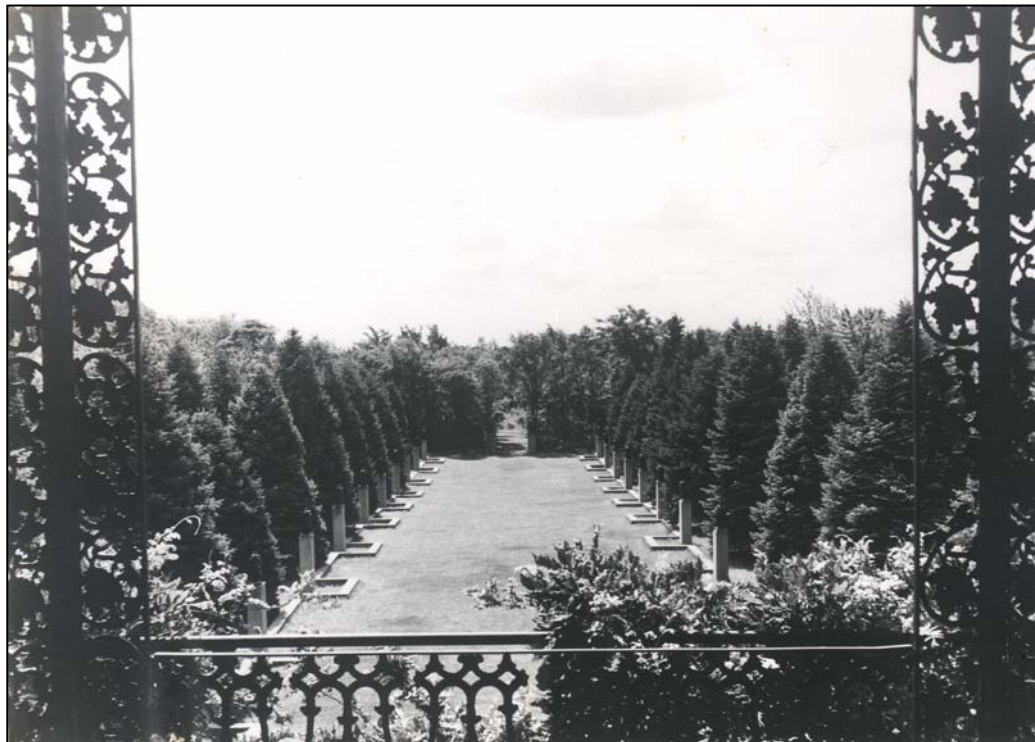

1951 (HGFG-10) This view shows the iron gazebo framing the garden.



**CULTURAL LANDSCAPE TREATMENT PLAN  
ROBERT ALLERTON PARK, MONTICELLO, ILLINOIS**

---



**2001** – This current view shows the extent to which the plantings have grown out of scale. Compare with earlier views taken from the House of the Golden Buddhas.



**2001** – The Fu Dogs now appear in shade and are overshadowed by the white firs lining the garden. House of the Golden Buddhas is visible in the background.

### **DESCRIPTION**

The Fu Dog Garden, designed in 1932 to display Robert Allerton's collection of Chinese *Fu Dogs*, is located on the northeast side of the property, removed from the other formal gardens except for the Vine Walk, which leads up to it. Twenty-two blue ceramic *Fu Dogs* on concrete pedestals form the main feature of this garden, which extends south from the House of the Golden Buddhas.

The 1948 plant inventory indicates that there were 44 specimen white firs planted in two rows on each side of the garden, with the inner row of trees spaced 7 feet behind the wall and 30 feet apart. The firs were underplanted with over 700 clumps of white narcissus as well as wild white daisies (*Bellis perennis*) and wild pinks (*Dianthus armeria*). The northwest end of the garden was bordered by Iboya Privet (*Ligustrum obtusifolium*), Eastern Redbud (*Cercis canadensis*) and Indian Currant Coralberry (*Symphoricarpos orbiculatus*). The southwest end of the garden was bordered by a massed planting of Chinese elm (*Ulmus parvifolia*).

### **CHARACTER DEFINING FEATURES**

- Long, narrow rectangular space with House of the Golden Buddhas at northern end.
- Twenty-two blue-glazed ceramic Chinese *Fu Dogs* (nineteen 19<sup>th</sup> century originals and three replacements) are the primary feature of this garden. They are part dog, part lion and part dragon. The statues are in pairs of a male and corresponding female. They are mounted on concrete pedestals 64 inches high, 27 inches wide, and 15½ inches deep.
- Sawtooth concrete curbing has been used to define the garden spaces since at least 1935. Prior to that the space was defined by low triangular-shaped privet hedging which was soon removed because it was difficult to maintain.
- A double row of 44 white fir trees, selected on the basis of their complimentary blue color and longevity in the Illinois landscape, were planted behind the *Fu Dogs* to serve as a backdrop. The original trees are now becoming overgrown and many are missing.
- Concrete pillars marking the southern edge of the garden and the pathway to the goldfish pond.

### **ISSUES/RECOMMENDATIONS**

Images HGFG 8 and 10, taken in 1944 and 1951 respectively, show the intended effect of the garden, with the sunlit *Fu Dogs* backed by rows of specimen fir trees. In the intervening years the firs have grown out of scale, obscuring the *Fu Dogs*, which were meant to be the focal point of the garden, and destroying the formality of the space, as the firs have lost their pyramidal shape or been removed. Preservation is the recommended treatment, except for the plantings, which should be replaced to re-establish the intended design.

#### **13A. *Fu Dogs***

*Fu Dogs* are fragile and some have been poorly repaired in the past. The three replacement copies are of poor quality. Follow conservator's recommendations (Forsythe, 1994) regarding treatment and reproduction.

**13B. Adjacent Forest**

The forest adjacent to the Fu Dog Garden has become overgrown in time, crowding the white firs and making the garden smaller than intended. Prune back forest to re-establish earlier garden edge. Maintain area outside the curbing as low meadow grass (see images on previous pages).

**13C. White Firs**

Firs behind *Fu Dogs* have grown out of scale and are dominating the space rather than serving as a backdrop for the sculptures. They should be removed and replanted. This could happen all at once or could be phased to minimize the visual impact. Phasing could be accomplished as follows: prune back woods as recommended above and prune fir limbs that directly overhang *Fu Dogs*; remove outside row of firs and plant new outside row; remove inside rows of fir at such time that most are lost and replant with white fir. Replant white narcissus, wild white daisies, and wild pinks, which are documented on 1948 plant list.

**13D. South End of Garden**

Path to goldfish pond is not visible from garden. Clear and maintain an opening to woodland path at south end of garden to draw visitors to this area.

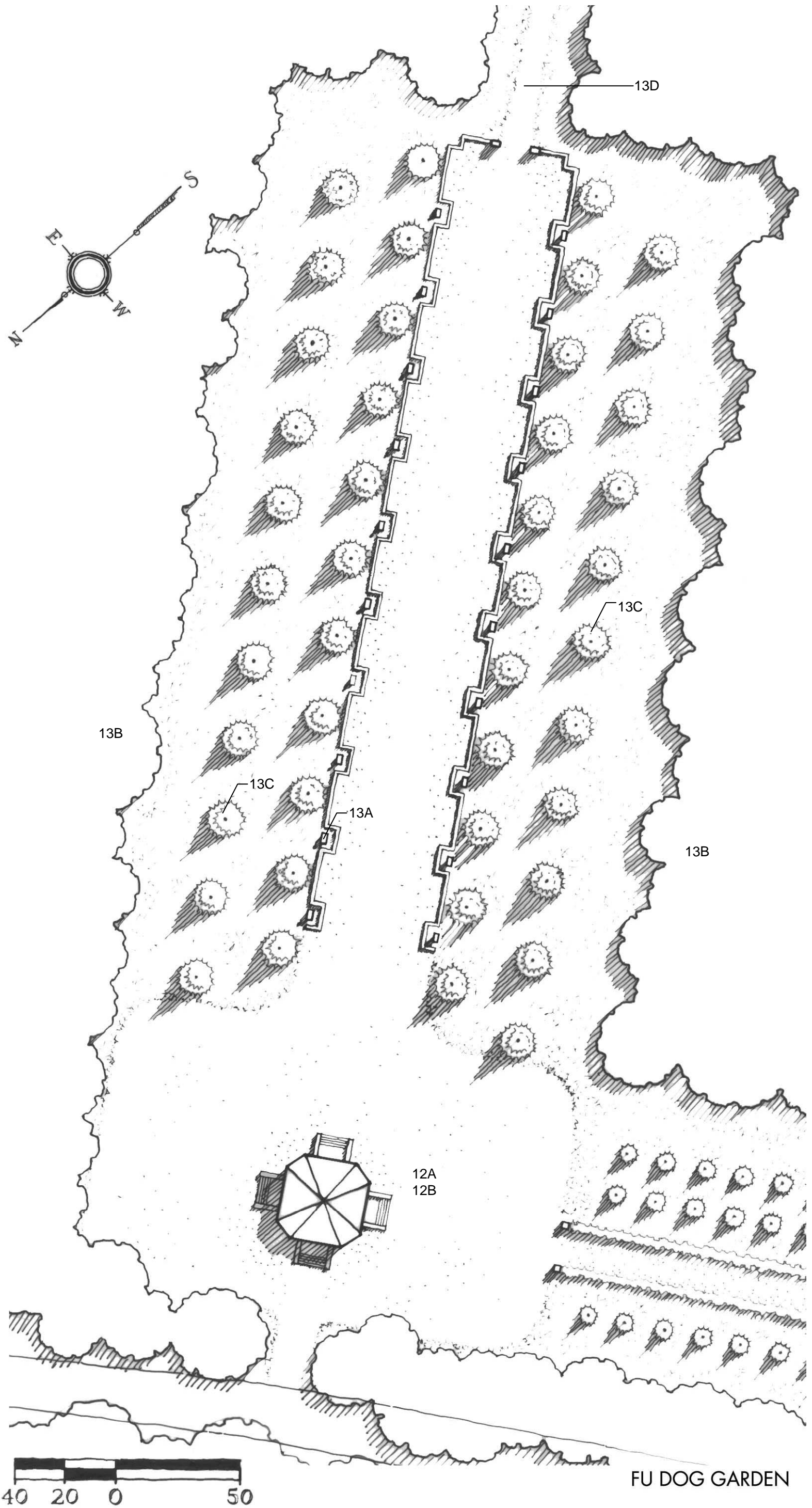



14. LOST GARDEN

---

GARDEN EVOLUTION



1938 (HGL-10) Early (west) view showing the *Chinese Musicians* lining the pathway and the openness of the surrounding former pasture. Note the mature forest in the background.



1937 (HGL-14) Another early (east) view showing plantings lining the pathway. Note the young succession field in the background.



1944 (HGL-26) By this the time the vegetation had matured, creating a more enclosed space.



1944 (HGL-29) This view shows the cedar-lined pathway, the primary feature that remains today.



1940 (HGL-23) Detail of teahouse.



1944 (HGL-24) This aerial view shows the extent to which the pasture surrounding the Lost Garden had become overgrown by the time the property was transferred to the University. Dark cedars and the teahouse are visible near the center of the picture.





Fall 2000 View along main pathway of Lost Garden showing remnant cedar allée.



Fall 2000 View looking west towards Lost Garden with sculpture platform for *Three Graces* in the foreground.

### **DESCRIPTION**

The Lost Garden, located at the southern end of the property, was designed by Robert Allerton in 1932 as a wilderness garden remote from the main house. Unlike most of the formal gardens at Allerton Park, this garden (also known as the Forgotten or Wilderness Garden) was designed to be viewed from a distance while enjoyed from within. The garden is linear with a formal allée of red cedar and extensive use of sculpture. The focal point of the garden was changed in 1935 with the addition of the teahouse, designed by John Gregg Allerton, near the center of the allée. This was a favorite picnic site. The teahouse burned in 1972 and all sculptural elements were subsequently removed to other gardens. Today only remnants of the garden remain. The small parking lot that leads to the garden was added in the 1960s and is used primarily by hikers. The Lost Garden continues to serve as a destination for the extensive trail system in the southern portion of the park.

### **CHARACTER DEFINING FEATURES**

- The garden, approximately 1,600 feet long by 40 feet wide, appears as a long narrow clearing in an otherwise natural landscape. Rolling topography adds to the sense of a natural space with formal geometry imposed on it.
- Lining the allée for most of its length is a double row of red cedars. There are also a few remnant ornamental and herbaceous plantings, notably yuccas.
- Remnant structures include: the foundation for the former tea house, a low brick wall, two columns, two sculpture platforms, and some saw tooth edging along the pea stone path.

### **ISSUES/RECOMMENDATIONS**

The Lost Garden exists today primarily as a remnant designed landscape in an otherwise natural setting. The area which encompasses the garden was designated a National Natural Landmark in 1971. The teahouse, which was the focal point of the garden, was destroyed by fire in 1972.

The recommendation for this garden is to preserve extant garden features (as described above) but not to restore any missing features. Restoration is not recommended because: difficult policy issues would be raised, including conflicts with Natural Landmark designation; there are extant gardens with far more pressing needs; and it would be difficult to assure adequate security for delicate sculptures in this remote area.

Expanded interpretation of the site is recommended (see overall interpretive recommendations) and periodic maintenance is recommended to assure safety and to preserve extant site features.

#### **14M1. Pruning**

Remove deadwood and weak, leaning or hazardous trees in allée regularly. Retain healthy trees. Prune edges periodically to prevent narrowing of corridor. Mow grass periodically during growing season.

#### **14M2. Structures**

Inspect columns and other structures regularly to assure that they are structurally sound and do not present a hazard.

**CULTURAL LANDSCAPE TREATMENT PLAN  
ROBERT ALLERTON PARK, MONTICELLO, ILLINOIS**

---

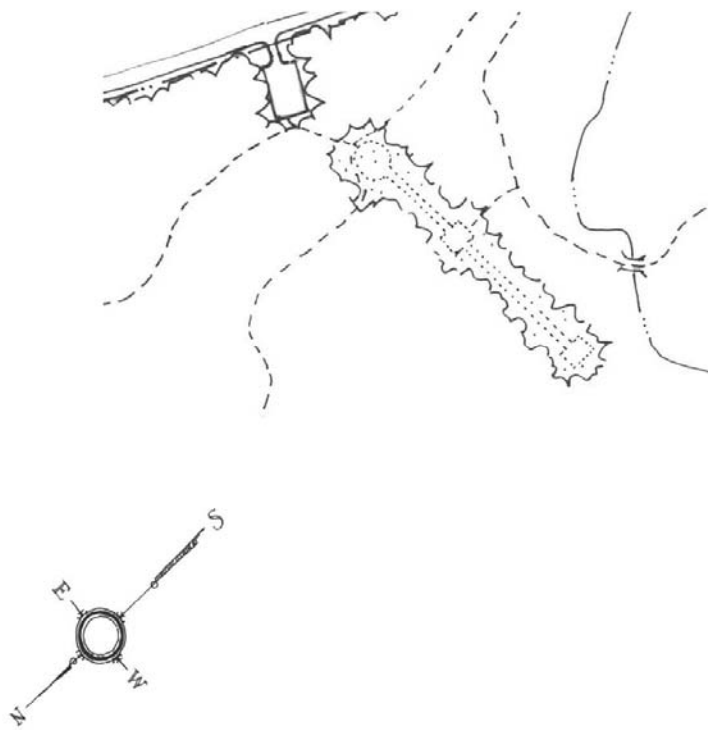

SCALE: 1" = 400'

LOST GARDEN



**BIBLIOGRAPHY**

---

Note: The primary repository consulted for this project was the archives onsite at Robert Allerton Park. In addition to the sources below, an extensive collection of historic photographs were used, as were various publications of the University of Illinois.

Birnbaum, Charles and Lisa Crowder, Editors. *Pioneers of American Landscape Design: An Annotated Bibliography*. Washington, DC: US Department of the Interior, National Park Service, 1993.

Emmet, Alan. *So Fine a Prospect, Historic New England Gardens*. Hanover, NH: University Press of New England, 1995.

Farrar, William G. "National Register Nomination, Robert Allerton Park." Springfield: Illinois Historic Preservation Agency, 1974.

Genskow, Karen M. "The Country Estate in Illinois" in *Historic Illinois*. Vol. 10, No. 5, February 1988.

Griswold, Mac and Eleanor Weller. *The Golden Age of American Gardens, Proud Owners, Private Estates, 1890 - 1940*, New York: Harry N. Abrams Inc., 1991.

Highland Park Historic Preservation Commission. "Highland Park, IL, Historic Landscape Survey, Final Report." Unpublished manuscript, 1988.

Keller, J. Timothy and Genevieve P., *National Register Bulletin 18, How to Evaluate and Nominate Designed Historic Landscapes*, Washington, DC: National Park Service, 1989.

Kluesing, Cherie. Masters Thesis on Robert Allerton Park. Unpublished manuscript, Department of Landscape Architecture, University of Illinois, Champaign-Urbana, 1978.

National Park Service. *Guidelines for the Treatment of Cultural Landscapes*. Washington D.C., 1996.

Newton, Norman T., *Design on the Land, The Development of Landscape Architecture*, Cambridge, MA: The Belknap Press of Harvard University Press, 1971.

Punch, Walter T., ed. *Keeping Eden: a History of Gardening in America*. Boston: Massachusetts Horticultural Society, 1992.

Scheinman, Muriel. "Art Collecting at the University of Illinois, A History and Catalogue." Doctoral Thesis, Champaign-Urbana: University of Illinois, 1981.

Tishler, William, ed. *American Landscape Architecture: Designers and Places*. Washington, DC: The Preservation Press, 1989.

University of Illinois, Department of Civil Engineering. "Repair and Rehabilitation Strategies for the Robert Allerton Park Garden Wall." Unpublished student report, CE314, University of Illinois, Champaign-Urbana, 1996.

Western Waterproofing Co, Inc. "Proposal, Robert Allerton Park." November 2, 1999.

---

**CULTURAL LANDSCAPE TREATMENT PLAN**  
**Robert Allerton Park, Monticello, Illinois**

---

Woods, Amy Lamb. "Historic Concrete Repair Investigation at Robert Allerton Park."  
Unpublished student report, CE4981R, University of Illinois, Champaign-Urbana, 2000.